

GARMIN®

æra™

models: 795 and 796



Pilot's Guide

OVERVIEW

GPS NAVIGATION

FLIGHT PLANNING

HAZARD AVOIDANCE

ADDITIONAL FEATURES

APPENDICES

INDEX

Copyright © 2011 Garmin Ltd. or its subsidiaries. All rights reserved.

This manual reflects the operation of System Software version 0002.0 or later. Some differences in operation may be observed when comparing the information in this manual to earlier or later software versions.

Garmin International, Inc., 1200 East 151st Street, Olathe, Kansas 66062, U.S.A.
Tel: 913/397.8200 Fax: 913/397.8282

Garmin AT, Inc., 2345 Turner Road SE, Salem, OR 97302, U.S.A.
Tel: 503/391.3411 Fax 503/364.2138

Garmin (Europe) Ltd, Liberty House, Bulls Copse Road, Hounslow Business Park,
Southampton, SO40 9RB, U.K.
Tel: 44/0870.8501241 Fax: 44/0870.8501251

Garmin Corporation, No. 68, Jangshu 2nd Road, Shijr, Taipei County, Taiwan
Tel: 886/02.2642.9199 Fax: 886/02.2642.9099

Web Site Address: www.garmin.com

Except as expressly provided herein, no part of this manual may be reproduced, copied, transmitted, disseminated, downloaded or stored in any storage medium, for any purpose without the express written permission of Garmin. Garmin hereby grants permission to download a single copy of this manual and of any revision to this manual onto a hard drive or other electronic storage medium to be viewed for personal use, provided that such electronic or printed copy of this manual or revision must contain the complete text of this copyright notice and provided further that any unauthorized commercial distribution of this manual or any revision hereto is strictly prohibited.

Garmin®, FliteCharts®, SafeTaxi®, and MapSource® are registered trademarks of Garmin Ltd. or its subsidiaries. aera™ is a trademark of Garmin Ltd. or its subsidiaries. These trademarks may not be used without the express permission of Garmin.

Jeppesen® is a registered trademark of Jeppesen, Inc.

NavData™ is a trademark of Jeppesen, Inc.

SiriusXM® is a registered trademark of SiriusXM Satellite Radio, Inc.

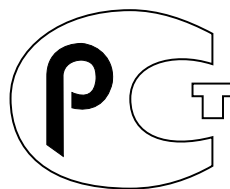

MP02



WARNING: When installing the aera™ 795/796, place the unit so it does not obstruct the field of view or interfere with operating controls.



WARNING: The indicators represented on the Panel are based on GPS-derived data and may differ from the instruments in the aircraft.



WARNING: Navigation and terrain separation must NOT be predicated upon the use of the terrain function. The aera 795/796 Terrain Proximity feature is NOT intended to be used as a primary reference for terrain avoidance and does not relieve the pilot from the responsibility of being aware of surroundings during flight. The Terrain Proximity feature is only to be used as an aid for terrain avoidance and is not certified for use in applications requiring a certified terrain awareness system. Terrain data is obtained from third party sources. Garmin is not able to independently verify the accuracy of the terrain data.



WARNING: The displayed minimum safe altitudes (MSAs) are only advisory in nature and should not be relied upon as the sole source of obstacle and terrain avoidance information. Always refer to current aeronautical charts for appropriate minimum clearance altitudes.



WARNING: The altitude calculated by aera 795/796 GPS receivers is geometric height above Mean Sea Level and could vary significantly from the altitude displayed by pressure altimeters. Always use pressure altitude displayed by the aircraft altimeter when determining or selecting aircraft altitude.



WARNING: Do not use outdated database information. Databases used in the aera 795/796 system must be updated regularly in order to ensure that the information remains current. Pilots using any outdated database do so entirely at their own risk.



WARNING: SiriusXM Weather should not be used for hazardous weather penetration. Weather information is approved only for weather avoidance, not penetration.



WARNING: NEXRAD weather data is to be used for long-range planning purposes only. Due to inherent delays in data transmission and the relative age of the data, NEXRAD weather data should not be used for short-range weather avoidance.



WARNING: The illustrations in this guide are only examples. Never use the aera 795/796 to attempt to penetrate a thunderstorm. Both the FAA Advisory Circular, Subject: Thunderstorms, and the Aeronautical Information Manual (AIM) recommend avoiding “by at least 20 miles any thunderstorm identified as severe or giving an intense radar echo.”



WARNING: To reduce the risk of unsafe operation, carefully review and understand all aspects of the aera 795/796 Pilot’s Guide documentation and the Pilot’s Operating Handbook of the aircraft. Thoroughly practice basic operation prior to actual use. During flight operations, carefully compare indications from the aera 795/796 to all available navigation sources, including the information from other NAVAIDs, visual sightings, charts, etc. For safety purposes, always resolve any discrepancies before continuing navigation.



WARNING: The Garmin aera 795/796 has a very high degree of functional integrity. However, the pilot must recognize that providing monitoring and/or self-test capability for all conceivable system failures is not practical. Although unlikely, it may be possible for erroneous operation to occur without a fault indication shown by the aera 795/796. It is thus the responsibility of the pilot to detect such an occurrence by means of cross-checking with all redundant or correlated information available in the cockpit.



WARNING: For safety reasons, aera 795/796 operational procedures must be learned on the ground.



WARNING: The United States government operates the Global Positioning System and is solely responsible for its accuracy and maintenance. The GPS system is subject to changes which could affect the accuracy and performance of all GPS equipment. Portions of the Garmin aera 795/796 utilize GPS as a precision electronic NAVigation AID (NAVAID). Therefore, as with all NAVAIDs, information presented by the aera 795/796 can be misused or misinterpreted and, therefore, become unsafe.



WARNING: The data contained in the terrain and obstacle databases comes from government agencies. Garmin accurately processes and cross-validates the data, but cannot guarantee the accuracy and completeness of the data.



WARNING: Do not use basemap (land and water data) information for primary navigation. Basemap data is intended only to supplement other approved navigation data sources and should be considered as an aid to enhance situational awareness.



BATTERY WARNINGS:

If these guidelines are not followed, the internal lithium-ion battery may experience a shortened life span or may present a risk of damage to the GPS device, fire, chemical burn, electrolyte leak, and/or injury.

- Do not leave the device exposed to a heat source or in a high-temperature location. To prevent damage, remove the device from the aircraft or store it out of direct sunlight.
- Do not puncture or incinerate the device or battery.
- When storing the device for an extended time, store within the following temperature range: from 32° to 77°F (from 0° to 25°C)
- Do not operate the device outside of the following temperature range: from -4° to 131°F (from -20° to 55°C).
- Contact your local waste disposal department to dispose of the device/battery in accordance with applicable local laws and regulations.

Additional User-Replaceable Battery Warnings:

- Do not use a sharp object to remove the battery.
- Keep the battery away from children.
- Do not disassemble, puncture, or damage the battery.
- Only replace the battery with the correct replacement battery. Using another battery presents a risk of fire or explosion. To purchase a replacement battery, see your Garmin dealer or the Garmin Web site.



CAUTION: Avoid using any chemical or abrasive cleaners on the touchscreen and/or plastic casing. Clean the touchscreen with a soft, clean, lint-free cloth. Use water, isopropyl alcohol, or eyeglass cleaner, if needed.



CAUTION: The Garmin aera 795/796 does not contain any user-serviceable parts. Repairs should only be made by an authorized Garmin service center. Unauthorized repairs or modifications could void both the warranty and the pilot's authority to operate this device under FAA/FCC regulations.



NOTE: All visual depictions contained within this document, including screen images of the aera 795/796 panel and displays, are subject to change and may not reflect the most current aera 795/796 system and aviation databases. Depictions of equipment may differ slightly from the actual equipment.



NOTE: This product, its packaging, and its components contain chemicals known to the State of California to cause cancer, birth defects, or reproductive harm. This notice is being provided in accordance with California's Proposition 65. If you have any questions or would like additional information, please refer to our web site at www.garmin.com/prop65.



NOTE: Interference from GPS repeaters operating inside nearby hangars can cause an intermittent loss of attitude and heading displays while the aircraft is on the ground. Moving the aircraft more than 100 yards away from the source of the interference should alleviate the condition.



NOTE: Use of polarized eyewear may cause the flight displays to appear dim or blank.



NOTE: Temporary Flight Restriction (TFR) data is provided by the FAA and may not be updated outside of normal business hours. Confirm data currency through alternate sources and contact your local FSS for interpretation of TFR data.

Blank Page

Section 1 Overview	1
1.1 Unit Overview.....	1
1.2 Getting Started	2
Battery Installation	2
Charging the Battery	3
Mounting the aera 795/796 in the Aircraft.....	4
Turning the Unit On/Off	5
GPS Receiver Status	6
Display Orientation.....	8
1.3 Operation.....	8
Basic Touchscreen Operation	8
Dedicated Icons.....	10
Page Buttons (Optional)	10
Main Menu.....	11
1.4 Menus and Data Entry	15
Option Menus	15
Data Entry.....	15
1.5 Using Map Displays.....	18
Map Range	18
Map Panning	20
Map Overlays.....	22
Map Symbols	22
1.6 System Settings	23
Display.....	24
Sound.....	26
Additional Settings.....	27
1.7 Nearest Airport Criteria Settings	28
1.8 Present Position	28
Position.....	28
New Location.....	29
Simulator Mode	29
Section 2 GPS Navigation.....	31
2.1 Introduction.....	31
Data Fields.....	32
Numeric Flight Data	35
Compass Arc.....	36
2.2 HSI/Panel.....	37
Setting the Bug Indicator	38
Manually Setting a Course.....	38
2.3 Vertical Navigation (VNAV)	39
Using the VNAV Feature	40

2.4 Map Display Setup	42
Map Orientation	43
Airports, Nav aids, Cities & Roads	43
Airways	44
2.5 Waypoints	44
Waypoint Information	45
Waypoint Frequencies	47
Waypoint Weather Information	48
Airport Directory Waypoint Information	48
Viewing Chart Information by Identifier	49
Nearest Information	50
Textual Weather Information	52
Accessing Additional information	54
2.6 Direct-to Navigation	63
Section 3 Flight Planning	65
3.1 Introduction	65
Data Fields	66
3.2 Flight Plan Creation	67
Adding Waypoints to an Existing Flight Plan	69
3.3 Flight Plan Storage	70
3.4 Flight Plan Activation	70
3.5 Flight Plan Editing	71
Editing Speed and Fuel Flow	71
Copying Flight Plans	72
Deleting Flight Plans	72
Inverting a Flight Plan	73
Importing/Exporting Flight Plans	74
3.6 Approaches	74
Selecting an Approach	75
Activating Vectors-to-Final	77
Section 4 Hazard Avoidance	79
4.1 SIRIUSXM® Weather (aera 796)	79
Activating Services	79
SIRIUSXM Satellite Weather Products	80
Using SIRIUSXM Satellite Weather Products	92
4.2 Terrain	95
Terrain Information	96
Obstacle Information	96
Terrain and Obstacle Color Code	97
Terrain Views	98

Terrain Alerts & Setup.....	99
4.3 Traffic Information Service (TIS).....	101
TIS Symbology.....	101
TIS Alerts	102
Traffic Ground Track	103
Displaying Traffic Data	103
Section 5 Additional Features.....	105
5.1 3D Vision	106
3D Vision Operation	107
5.2 Airport Directory Data.....	109
5.3 ChartView	111
Aircraft Symbol.....	112
Chart Range.....	113
Jeppesen Database-published NOTAMS	113
5.4 FliteCharts.....	114
Aircraft Symbol.....	116
FliteChart Range	116
FliteCharts Cycle Number and Expiration Date	117
5.5 VFR/IFR Chart Viewing	117
5.6 SafeTaxi.....	118
SafeTaxi Cycle Number and Revision	119
5.7 SiriusXM® Radio (aera 796)	119
Activating SiriusXM Satellite Radio Services	120
Using SiriusXM Radio	121
5.8 Electronic Checklists	126
Section 6 Appendices.....	127
Appendix A: Messages, Alerts & Data Field Options	127
Miscellaneous Message Advisories.....	127
Airspace Messages.....	129
Data Field & Numeric Data Options	129
Aural Alerts.....	131
Appendix B: Abnormal Operation.....	133
Loss of GPS Position	133
Hazard Display with Loss of GPS Position.....	133
Appendix C: SD Cards and Databases	134
SD Card Use.....	134
Databases.....	135
Appendix D: Installation and Interfacing	139
Mounting the aera 795/796 in the Aircraft.....	139
Connecting to a Computer	143

Connecting to a Garmin VHF Comm Radio.....	144
Connecting the GXM 40 Antenna (aera 796).....	146
Connecting to a GTX 330 Mode S Transponder.....	147
Interfacing.....	147
Using an external GPS Antenna (Optional).....	149
Appendix E: Battery and Care Information.....	151
Battery Information.....	151
Changing the Cigarette Lighter Adapter Fuse.....	151
Cleaning the Casing.....	152
Cleaning the Touchscreen.....	152
Protecting the Unit.....	152
Appendix F: General TIS Information.....	153
TIS vs. TAS/TCAS.....	153
TIS Limitations.....	153
Appendix G: Utilities.....	157
Document Viewer.....	157
Scratch Pad.....	157
Flight Log.....	158
Track Log.....	160
Heading Line.....	163
E6B Calculator.....	164
Aircraft Profile.....	166
Weight & Balance.....	168
Proximity Waypoints.....	170
Appendix H: Display Symbols.....	173
VFR Symbols.....	173
IFR Symbols.....	174
Airspace Symbols.....	176
Appendix I: Map Datum and Location Formats.....	179
Map Datums.....	179
Location Formats.....	179
Appendix J: Glossary.....	181
Appendix K: License Agreement and Warranty.....	187
Contact Garmin.....	187
Software License Agreement.....	187
Limited Warranty.....	187
AOPA Airport Directory Notice.....	188
SIRIUSXM Satellite Radio Service Agreement.....	188
Weather Data Warranty.....	189
FCC Compliance.....	190
Industry Canada Compliance.....	190

SECTION 1 OVERVIEW

1.1 UNIT OVERVIEW

The aera 795/796 presents GPS-derived analog flight instrumentation, position, navigation, and hazard avoidance information to the pilot using a 7" WVGA high brightness display with capacitive Touch Screen.



Unit Overview (Left Side)



Unit Overview (Right Side)

1.2 GETTING STARTED

BATTERY INSTALLATION



NOTE: Refer to Appendix E for additional battery information.



CAUTION: Always keep the battery installed when the unit is on.



WARNING: The product contains a lithium-ion battery. To prevent damage, remove the unit from the aircraft or store it out of direct sunlight.

Installing the battery:

- 1) Locate the lithium-ion battery that came in the product box.
- 2) Locate the metal contacts on the end of the lithium-ion battery.
- 3) Insert the battery so that the metal contacts on the battery line-up with the metal contacts inside the battery compartment.
- 4) Insert the battery into the battery compartment, and push until it clicks into place.



Unit Overview (Back - Battery Out)

CHARGING THE BATTERY



NOTE: While in Charge Mode the unit draws a current from the aircraft. To avoid discharging the aircraft's battery, disconnect the external power cable from the unit when not in use for several days.

Charge the aera 795/796 for at least 4 hours before using on battery power. Charge the battery by connecting the aviation power cable or the AC adapter.

Plug the unit into a 12-Volt or 24-Volt connector to charge. The unit can be used while it is charging. Charge the unit within the following temperature range: 32° to 104°F (0° to 40°C).

Charging the unit's battery using the aircraft's power outlet:

- 1) Mount the aera 795/796 in the aircraft and connect the power cable to the aircraft power outlet (cigarette lighter receptacle).
- 2) Route the power cable so that it does not interfere with aircraft operation. The unit begins charging as soon as external power is applied.

USING CHARGE MODE

Applying external power to the aera 795/796 automatically turns on the unit for full operation. If the battery is present and needs to be charged, the external power source charges the battery while the unit is in use.

If you do not want to use the unit, but you would like to charge the battery, you can put the unit into Charge Mode. Connect the unit to an external power supply. Press and hold the  **POWER** Button. Instead of completely turning off, the unit now goes into Charge Mode.

The unit will run cooler and may allow more current to be available while in Charge Mode, when XM is unplugged, the backlight is turned down, etc.

MOUNTING THE aera 795/796 IN THE AIRCRAFT

Refer to Appendix D 'Installation & Interfacing' for information on mounting the aera 795/796 in the aircraft.

TURNING THE UNIT ON/OFF

Press and hold the  **POWER** Button to turn the unit on or off.

The first time the unit is turned on, the receiver must collect satellite data and establish its present location. To ensure proper initialization, the aera 795/796 is shipped from the factory in AutoLocate mode, which allows the receiver to “find itself” anywhere in the world.

During initialization, current database information is displayed. Database information includes valid operating dates, cycle number, and database type. When this information has been reviewed for currency (to ensure that no databases have expired), the pilot is prompted to continue.

Touching the **Press To Accept** Button acknowledges this information, and the **Main Menu** is displayed.



aera 795



aera 796

Database Initialization

GPS RECEIVER STATUS

The receiver status displays one of the following conditions:

- AutoLocate—Receiver is looking for any satellite whose almanac has been collected, which can take up to 5 minutes
- Searching the Sky—Receiver is looking for satellites
- Acquiring Satellites—Receiver is looking for and collecting data from satellites visible at its last known or initialized location, but has not acquired a fix
- 2D GPS Location—At least three satellites have been acquired and a two-dimensional location fix has been calculated. “2D Differential” appears when you are receiving DGPS corrections in 2D mode
- 3D GPS Location—At least four satellites have been acquired and a three-dimensional fix has been calculated. “3D Differential” appears when you are receiving DGPS corrections in 3D mode
- Lost Satellite Reception—the receiver is no longer tracking enough satellites for a 2D or 3D fix



GPS Status

Viewing the GPS status:

From the **Main Menu**, touch **Tools** > **GPS Status**.

ACQUIRING SATELLITES

The  bars located at the top of the screen indicate the GPS signal strength.

When the receiver is in the process of acquiring enough satellite signals for navigation, the receiver uses satellite orbital data (collected continuously from the satellites) and last known position to determine the satellites that should be in view. 'Acquiring Satellites' is indicated as the solution until a sufficient number of satellites have been acquired for computing a solution.

When the receiver is in the process of acquiring a 3D differential GPS solution, '3D GPS Location' is indicated as the solution until the 3D differential fix has finished acquisition.

SATELLITE INFORMATION

Satellites currently in view are shown at their respective positions on a satellite constellation diagram. The outer circle of the constellation diagram represents the horizon, the inner circle represents 45° above the horizon, and the center point shows the position directly overhead. Each satellite is represented by a square containing the Pseudo-Random Noise (PRN) number (i.e., satellite identification number).

GPS Status can be helpful in troubleshooting weak (or missing) signal levels due to poor satellite coverage or installation problems. As the GPS receiver locks onto satellites, a signal strength bar is displayed for each satellite in view, with the appropriate satellite PRN number (01-32 or 33-64 for WAAS) below each bar. The progress of satellite acquisition is shown in three stages, as indicated by signal bar appearance:

- No bar—Receiver is looking for the indicated satellite
- Gray bar—Receiver has collected the necessary data and the satellite signal can be used
- Green bar—Satellite is being used for the GPS solution

DISPLAY ORIENTATION

The aera 795/796 can be viewed in either Portrait or Landscape Mode.

Changing the display orientation:

- 1) From the **Main Menu**, touch **Tools** > **Setup** > **Display**

Or:

Press the Power Button once quickly.

- 2) Touch the 'Display Orientation' datafield to select **Portrait** or **Landscape**.

1.3 OPERATION

BASIC TOUCHSCREEN OPERATION

Touch the desired selection. The icon, view, menu option, datafield, etc, will momentarily turn blue when selected.



Basic Touchscreen Operation

SCROLLING AND PANNING

Scrolling and panning on the touchscreen:

Drag up or down to scroll menus, documents, etc.

Or:

Drag in any direction to pan maps or charts.

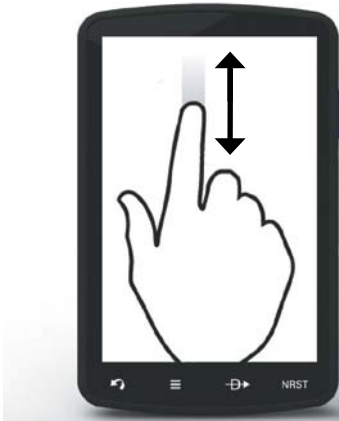

Scrolling

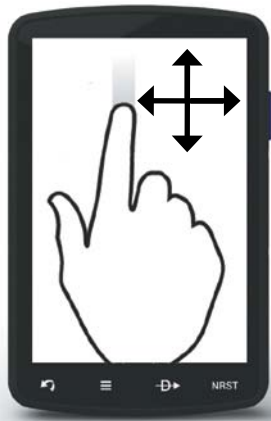

Panning

ZOOMING

Zooming in and out on the touchscreen map displays:

Pinch fingers together (zoom out), or pull fingers apart (zoom in).



Zoom Out







Zoom In

DEDICATED ICONS

Located on the bezel (below the touchscreen) are four dedicated touch icons. Touch or touch and hold the following icons to perform the associated function:

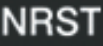

Dedicated Icons

	Back	Returns to previous screen. Cancels the map pointer.
	Main Menu (Shortcut)	Touch and hold to display the Main Menu.
	Menu	Displays the context sensitive option menu.
	Direct-to	Displays the Direct-to function.
	NRST	Displays the Nearest Icons. Touch and hold to quickly access the nearest airports.

PAGE BUTTONS (OPTIONAL)



NOTE: The aera 795/796 Optional Page Buttons are User Configurable.

Six different configurable Page Buttons are located above the Dedicated Icons. The Page Buttons default to (**Map**, **WPT Info**, **Weather** (aera 796), **Terrain**, **3D Vision**, and **Charts**).



Page Buttons

Configuring the Page Buttons:

- 1) **Main Menu**, touch **Tools** > **Setup** > **Display** > **Choose Buttons**
- 2) From the available Page Buttons at the top half of the screen, touch the new Page Button that will replace one of the current Page Buttons.
- 3) From the current Page Buttons along the bottom of the screen, touch the

Page Button that will be replaced by the new page button. The current Page Button is now replaced by the new Page Button.













- 4) Touch **Save**.

MAIN MENU

Touch and hold the  icon at any time to display the **Main Menu**.

MAIN MENU ICONS

Touch the following icons to display the associated function:









	Map	Displays the Map View.
	Terrain	Displays the Terrain View.
	3D Vision	Displays 3D Vision.
	WPT Info	Displays the Waypoint Information.
	FPL List	Displays the Flight Plan List.
	Active FPL	Displays the Active Flight Plan.
	Numbers	Displays flight data.
	Doc Viewer	Displays the document viewer.
	Charts	Displays the VFR or IFR charts.
	Weather	Displays second-level Weather Icons (aera 796).
	SiriusXM	Displays SiriusXM Radio (aera 796).
	Tools	Displays second-level Tools Icons.

NEAREST ICONS

Touch the  icon at any time to access the second-level Nearest icons.

Touch the following icons to display the associated function:









	Airport	Displays nearest airports.
	Airport WX	Displays nearest airport weather.









	VOR	Displays nearest VORs.
	NDB	Displays nearest NDBs.
	Intersection	Displays nearest intersections.
	VRP	Displays nearest Visual Reporting Point (VRP) (Atlantic).
	User WPT	Displays nearest user waypoints.
	City	Displays nearest cities.
	ARTCC	Displays nearest ARTCCs (Air Route Traffic Control Centers).
	FSS	Displays nearest Flight Service Stations (FSS).
	Airspace	Displays nearest airspace.

WEATHER ICONS (aera 796)

From the **Main Menu**, touch the **Weather** icon to access the second-level Weather Icons.

Touch the following second-level Icons to display the weather product:











	NEXRAD	Displays NEXRAD (NEXT-generation RADar).
	Satellite	Displays Satellite Mosaic cloud cover.
	Echo Tops	Displays Echo Tops.
	Winds	Displays Winds Aloft.
	Lightning	Displays Lightning.
	Storm Cells	Displays Storm Cells.
	METAR	Displays METARs.
	AIRMET	Displays AIRMETs.
	SIGMET	Displays SIGMETs.

	TFR	Displays TFRs (Temporary Flight Restrictions).
	PIREP	Displays PIREPs.
	Freeze Lvl	Displays Freezing Levels.
	Turb Fcst	Displays the Turbulence Forecast.
	Icing Fcst	Displays the Icing Forecast.
	WX Frst	Displays Forecast Information (current, 12hr, 24hr, 36hr, & 48hr).
	Pressure	Displays Surface Pressure.
	Sea Temp	Displays Water Temperature.

TOOLS

From the **Main Menu**, touch the **Tools** Icon to access the second-level Tools icons.

Touch the following second-level icons to display the associated function:

	Setup	Displays third-level Setup Icons.
	User WPT	Displays User Waypoints and Proximity Waypoints.
	Flight Log	Displays Flight Logs.
	Track Log	Displays Track Logs.
	VNAV	Displays Vertical Navigation.
	Profile	Displays Aircraft Profiles.
	E6B Calc	Displays the E6B Calculator.
	Weight/Bal	Displays the Weight & Balance.
	Database	Displays database and software version information.
	Position	Displays the aircraft's Present Position.



- Checklists** Displays the checklists if available.
- Scratchpad** Displays the scratchpad.
- GPS Status** Displays GPS status information.

SETUP ICONS

From the **Main Menu**, touch the **Tools > Setup** to access the third-level Setup Icons.

Touch the following third-level icons to perform the associated function:



Display Displays backlight intensity/timeout and color mode settings.



Sound Displays sound settings.



Units Displays unit settings.



Date/Time Displays date & time settings.



Map Displays Navigation Map settings.



Position Displays position settings.



Interface Displays interface settings.



Alarms Displays alarm settings.



SUA Alarms Displays Special Use Airspace alarm settings.



Power Displays Power Loss Warning settings.



Keyboard Displays keyboard layout settings.

1.4 MENUS AND DATA ENTRY

OPTION MENU

The aera 795/796 has a dedicated  icon that displays a context-sensitive list of menu options available.

Navigating the option menu:





- 1 Touch the  icon
- 2 Touch the desired menu option.



DATA ENTRY

DATA ENTRY ICONS

The following icons are displayed on the data entry screen.

	OK	Exits the keypad function and accepts the changes.
	BKSP	Erases the current data.
	Numeric/ Alpha/Symbol	Displays the numeric, alpha, or symbol keypad.
	Cancel	Cancels a value that has been edited.

Entering alphanumeric data:

- 1 When alphanumeric data can be entered, a keypad will appear after touching the desired datafield.
- 2 Touch the keypad to enter the desired data.
- 3 Touch **OK**.



Entering predetermined data options:

- 1 Touch the Data Option Button to display a vertical list of data options (if applicable), or to toggle two data options (i.e., On/Off).

Or:

Touch the  buttons to cycle through a horizontal list (if more than two data options are available).

- 2 If using the vertical list, touch the desired data option from the list.



1.5 USING MAP DISPLAYS



NOTE: Refer to the GPS Navigation section for more information on Map Display Setup.

Map displays are used extensively in the aera 795/796 to provide situational awareness in flight. Most aera 795/796 maps can display the following information:

- Airports, NAVAIDs, airspaces, airways, land data (highways, cities, lakes, rivers, borders, etc.) with names
- Map Pointer information (distance and bearing to pointer, location of pointer, name, and other pertinent information)
- Map range
- Aircraft icon (representing present position)
- Flight plan legs
- User waypoints
- Track vector
- Topography data

MAP RANGE

There are 23 different map ranges available, from 200 feet to 800 nm. The current map range is indicated in the lower right. The scale bar represents the map scale.

Changing the map range:

Use the  (out) or  (in) icons to zoom 'out' (increasing), or zoom 'in' (decreasing).



Or:

Pinch fingers together (zoom out), or pull fingers apart (zoom in).



Zoom Out



Zoom In

OVERZOOM

When the selected range exceeds the resolution of the map data, 'overzoom' appears below the map range scale.



Scale Bar Representing a Map Scale of 3 nm Per Scale Width.

Map Range/Overzoom

AUTO ZOOM

Auto Zoom allows the aera 795/796 to change the map display range to the smallest range clearly showing the active waypoint. Auto Zoom can be overridden by adjusting the range and remains that way until the active waypoint changes, a terrain or traffic alert occurs, or the aircraft takes off.

Enabling/disabling auto zoom:

- 1) From the **Main Menu**, touch **Map > Menu > Set Up Map**.
- 2) Touch the  buttons to select the '**General**' Category.
- 3) Touch the '**On/Off**' Data Option Button for 'Autozoom'.

MAP PANNING

Map panning allows the pilot to:

- View parts of the map outside the displayed range without adjusting the map range
- Highlight and select locations on the map
- Review information for a selected airport, NAVAID or user waypoint
- Designate locations for use in flight planning
- View airspace and airway information

When the panning function is selected by touching anywhere on the Map, the Map Pointer is displayed. An Information Window also appears at the bottom of the map display showing the bearing, distance and time to the pointer from the aircraft's present position, the elevation of the land at the position of the pointer, or the object's (airports, obstacles, etc) elevation, if known.

When the Map Pointer is over a map feature, the map feature is highlighted, an information box appears on the map, and the highlighted map feature is displayed on the Map Feature Button (even if the name was not originally displayed on the map).

Touching the **Map Feature** Button displays additional information for the highlighted map feature. If multiple features are present at the Map Pointer position, green arrows will appear on the Map Feature Button. Touching the will cycle through the list of map features present at that position.

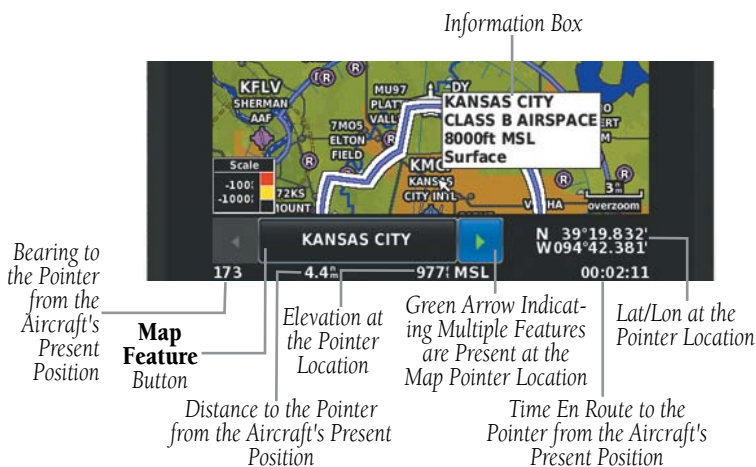

Map Panning (Navigation Map)







Activating the map pointer:

While viewing a Map Display, touch anywhere on the map to activate the map pointer. Touch the  icon to cancel the map pointer.

Panning the map:

While viewing a Map Display, touch anywhere on the map and drag.

Reviewing information for a map feature:

- 1 While viewing a Map Display, touch anywhere on the map to activate the map pointer. When the Map Pointer is over a map feature, the map feature is highlighted, an information box appears on the map, and the highlighted map feature is displayed on the Map Feature Button (the button located between the   buttons). If multiple features are present at the Map Pointer position, green arrows will appear on the Map Feature Button.
- 2 If necessary, touch the   buttons to cycle through the list of map features present at that position. Touching the   buttons changes the highlight and description.
- 3 Touch the Map Feature Button to review information for the Map Feature.
- 4 If desired touch the **Direct-to**  Icon to navigate to the map feature.

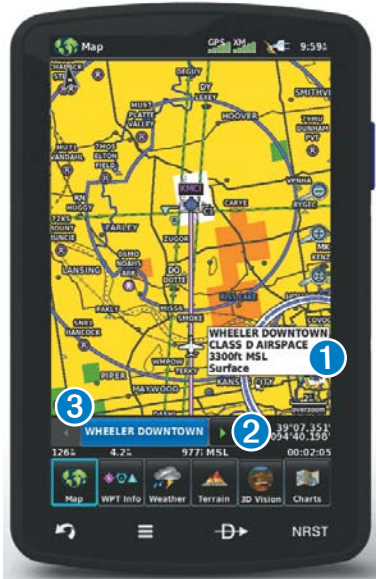

MAP OVERLAYS

The **1** Weather, **2** Topography, and **3** Terrain map overlays can be displayed or removed.



Displaying/removing map overlays:

- 1) From the **Main Menu**, touch **Map > Menu > Show/Hide**.
- 2) Touch the **'Show/Hide'** Data Option Button for the desired overlay.

MAP SYMBOLS

Refer to Appendix H for a list of map symbols.

DECLUTTER

The map can be adjusted to declutter (remove unwanted items, such as highways) the map.

Adjusting the declutter level of the navigation map:

- 1) From the **Main Menu**, touch **Map > Menu > Declutter**.
- 2) Touch the desired level (**none**, **-1**, **-2**, **-3**) at the bottom of the screen. The currently selected level is highlighted blue.
- 3) Touch the  icon to remove the detail options.

MAP DETAIL

The map detail can also be adjusted. Map detail changes the amount of detail with respect to the zoom scale.

Adjusting the map detail:

- 1) From the **Main Menu**, touch **Map > Menu > Set Up Map**.
- 2) Touch the  buttons to select the '**General**' Category.
- 3) Touch **Detail Level** Data Option Button, and touch the desired option from the list (**Least, Less, Normal, More, or Most**).

1.6 SYSTEM SETTINGS

The third-level **Setup** Icons allow management of the following system parameters:

- Display
- Sound
- Units
- Date & Time
- Map
- Position
- Interface
- Alarms
- SUA Alarms
- Power
- Keyboard

Restoring system setting defaults:

- 1) From the **Main Menu**, touch **Tools > Setup**.
- 2) Touch the desired Setup Icon (**Display, Sound, Units, Date & Time, Map, Position, Interface, Alarms, SUA Alarms, Power, or Keyboard**).
- 3) Touch **Menu > Restore Default**.

Or:

From the **Main Menu**, touch **Tools > Setup > Menu > Restore All Settings**.

DISPLAY



NOTE: Display Setup can also be accessed through the 'Quick Settings' by pressing the  POWER Button once quickly.

DISPLAY ORIENTATION

The aera 795/796 can be viewed in either Portrait or Landscape Mode.

Changing the display orientation:

- 1) From the **Main Menu**, touch **Tools** > **Setup** > **Display**

Or:

Press the Power Button once quickly.

- 2) Touch the 'Display Orientation' datafield to select **Portrait** or **Landscape**.

PAGE BUTTONS

Configuring the Page Buttons:

- 1) **Main Menu**, touch **Tools** > **Setup** > **Display** > **Choose Buttons**
- 2) Touch one of the available Page Buttons at the top half of the screen to replace one of the current Page Buttons.
- 3) Touch one of the current Page Buttons along the bottom of the screen to replace it with the new Page Button.
- 4) Touch **Save**.

Displaying/removing the Page Buttons:

- 1) From the **Main Menu**, touch **Tools** > **Setup** > **Display**.
- 2) Touch the '**Show/Hide**' Data Option Button for the 'Page Buttons'

BACKLIGHT INTENSITY

Adjusting backlight intensity:

- 1) From the **Main Menu**, touch **Tools** > **Setup** > **Display**.
- 2) Touch the  buttons to adjust the backlight intensity.

Or:

Press the  **POWER** Button and enter the desired backlight intensity.

BACKLIGHT TIMEOUT

After a specified period of inactivity the backlight will turn off to save battery power.

Adjusting backlight timeout:

- 1) From the **Main Menu**, touch **Tools > Setup > Display**.
- 2) Touch the '**Backlight Timeout**' Data Option Button, and touch the desired option from the list (**Stays On, 15 Seconds, 30 Seconds, 1 Minute, or 2 Minutes**).

ZOOM BUTTONS

Displaying/removing the Zoom Buttons:

- 1) From the **Main Menu**, touch **Tools > Setup > Display**.
- 2) Touch the '**Show/Hide**' Data Option Button for the 'Zoom Buttons'.

COLOR MODE

Adjusting the color mode:

- 1) From the **Main Menu**, touch **Tools > Setup > Display**.
- 2) Touch the '**Color Mode**' Data Option Button, and touch the desired option from the list (**Auto, Day, or Night**).

SCREENSHOT

Enable/disable screenshots:

- 1) From the **Main Menu**, touch **Tools > Setup > Display**.
- 2) Touch the 'Screenshot' '**On/Off**' Data Option Button.
- 3) If enabling screenshots, touch '**OK**'. A camera button appears at the top of the screen. Touch the camera button to save a screenshot to the screenshot folder on the 'Garmin' drive.

AIRCRAFT POSITION ON MAP/CHARTS

Displaying/removing the aircraft position on maps/charts:

- 1) From the **Main Menu**, touch **Tools > Setup > Display**.
- 2) Touch the 'Aircraft Position' '**Show/Hide**' Data Option Button.

SOUND



NOTE: *Sound Settings can also be accessed through the 'Quick Settings' by pressing the  POWER Button once quickly.*

Sound is broken down into 'Master', 'Alerts', and 'Media'. 'Master' controls ALL sound. 'Alerts' and 'Media' are a percentage of the 'Master' sound. 'Alerts' refers to navigation phrases (e.g. "Pull Up"), and 'Media' refers to the XM radio volume. The Terrain Audio and Key Tones can also be toggled On/Off.

Adjusting the sound:

- 1) From the **Main Menu**, touch **Tools > Setup > Sound**.
- 2) Touch the  buttons to adjust the sound.

Or:

- 1) Press the  **POWER** Button to quickly access the **Master** volume/mute.
- 2) Touch **Menu > Sound Setup** to access ALL volume settings.

Enabling/disabling Terrain Audio, TIS Audio, and/or Key Tones:

- 1) From the **Main Menu**, touch **Tools > Setup > Sound**.
- 2) Touch the '**On/Off**' Data Option Button to toggle Terrain Audio, TIS Audio, or Key Tones on/off.

Muting the sound:

- 1) From the **Main Menu**, touch **Tools > Setup > Sound**.
- 2) Touch the  icon to mute the **Master**, **Alerts**, or **Media** audio. A blue 'X' will appear over the icon.

ADDITIONAL SETTINGS

Changing settings (Units, Date & Time, Position, Interface, Alarms, SUA Alarms, Power, and Keyboard):

- 1) From the **Main Menu**, touch **Tools > Setup**.
- 2) Touch the desired Settings Icon (**Units, Time, Position, Interface, Alarms, SUA Alarms, Power, or Keyboard**).
- 3) Touch the desired setting to change. If only two options are available, touching the field will toggle the two settings. If more than two options are available, a vertical list is displayed with a blue outline around the current setting. Touch the '+' or '-' buttons to increase/decrease the numerical values (if necessary).
- 4) Touch and hold  to return to the **Main Menu**.

Icon	Available Settings
Display	Backlight Intensity, Backlight Timeout, Color Mode, Screenshot
Sound	Master (0-10), Alerts (0-10), Media (0-10), Key Tone, Terrain Audio, TIS Audio
Units	Distance, Speed, Direction Display, Temperature, Altitude, Vertical Speed, Pressure, Fluid Volume
Date/Time	Time Format, Auto UTC Offset
Position	Location Format, Map Datum, Heading, Magnetic Variation
Interface	Serial Data Format
Alarms	Arrival, Next WPT, Proximity, Fuel Tank Reminder
SUA Alarms	Class B/TMA, Class C/TCA, Class D, Restricted, MOA, Other/ADIZ, Parachute Area
Power	Power Loss Warning
Keyboard	Layout

1.7 NEAREST AIRPORT CRITERIA SETTINGS

The Nearest Airports function allows the pilot to filter out airports that do not meet a defined criteria. Specific surface types and runway lengths can be defined, as well as the option to include private airports and/or heliports.

Runway Surface—allows you to set criteria for the type of surface on the runway:

- **Hard Only**—shows only runways with a concrete, asphalt, or similar sealed surface.
- **Hard or Soft**—shows all runways except water landing facilities.
- **Water Only**—shows only water landing facilities.
- **Any**—shows any runway, regardless of surface type, including water landing facilities.

Minimum Runway Length—allows the pilot to enter a specific length for the shortest runway allowed.

Entering airport criteria:

- 1) Touch **NRST > Airport > Menu > Set Airport Criteria**.
- 2) Touch the desired setting to change ('**Runway Surface**', '**Include Private Apts**', '**Include Heliports**') or touch the '+' or '-' buttons to increase/decrease the **Minimum Runway Length**.

Restoring airport criteria defaults:

Touch **NRST > Airport > Menu > Restore Default**.

1.8 PRESENT POSITION

POSITION

The Present Position function displays latitude, longitude, GPS altitude, reference waypoint, type, distance, direction, and bearing. The reference waypoint is designed to display the current position in relation to a prominent landmark. The pilot can change the reference waypoint 'Nearest Type' using the 'Change Nearest Type' menu option. By default the Nearest Type is set to 'Automatic', which will display the nearest large airport, enroute VOR, or city (in that order).

Changing the Nearest Type:

- 1) From the **Main Menu**, touch **Tools > Position > Menu > Change Nearest Type**.
- 2) Touch the desired nearest type ('Automatic', 'Airport', 'VOR', 'NDB', 'Intersection', 'City', or 'Waypoint').

Viewing the present position:

From the **Main Menu**, touch **Tools > Position**.

NEW LOCATION

The 'New Location' menu option is used when the GPS Receiver is having trouble finding the satellites it expects to be there. If 'Automatic' is selected, the GPS will attempt to figure out the new location.

Changing the New Location setting to automatic:

- 1) From the **Main Menu**, touch **Tools > Position > Menu > New Location**.
- 2) Touch '**Automatic**'. The GPS will attempt to figure out the new location.

Entering a new location:

- 1) From the **Main Menu**, touch **Tools > Position > Menu > New Location**.
- 2) Touch '**Use Map**' or '**Use Identifier**'.
- 3) After selecting your approximate position using the map pointer or entering an identifier, touch **OK**.
- 4) The GPS Receiver will begin a new search based on the location entered.

SIMULATOR MODE

Simulator Mode is helpful for practicing with the unit indoors or when satellite or XM signals are unavailable. All waypoints and routes created in Simulator Mode are retained in memory for future use.



NOTE: Do not attempt to navigate using Simulator Mode. When the unit is set to Simulator Mode, the GPS receiver is turned off. Any Satellite Signal Strength Bars shown are only simulations and do not represent the strength of actual satellite signals.

Starting/Stopping Simulator Mode:

From the **Main Menu**, touch **Tools** > **Position** > **Menu** > **Start/Stop Simulator**.

Adjusting the simulated altitude, track, speed, waypoint, & position:

- 1) From the **Main Menu**, touch **Tools** > **Position** > **Menu** > **Start Simulator**.
- 2) Touch **Menu** > **Drive Simulator**.
- 3) Enter the desired data by touching the fields or using the +/- buttons. Refer to Section 1.4 'Data Entry' for more information.

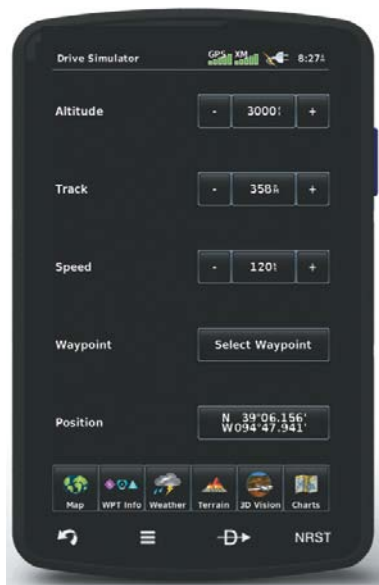

Drive Simulator

SECTION 2 GPS NAVIGATION

2.1 INTRODUCTION

The Navigation Map displays aviation data (e.g., airports, VORs, airways, airspaces), geographic data (e.g., cities, lakes, highways, borders), and topographic data (map shading indicating elevation). The Navigation Map can be oriented three different ways: North Up (NORTH UP), Track Up (TRK UP) or Desired Track Up (DTK UP).

An aircraft icon is placed on the Navigation Map at the location corresponding to the calculated present position. The aircraft position and the flight plan legs are accurately based on GPS calculations. The basemap upon which these are placed is from a source with less resolution, therefore the relative position of the aircraft to map features is not exact. The leg of the active flight plan currently being flown is shown as a magenta line on the navigation map. The other legs are shown in white.

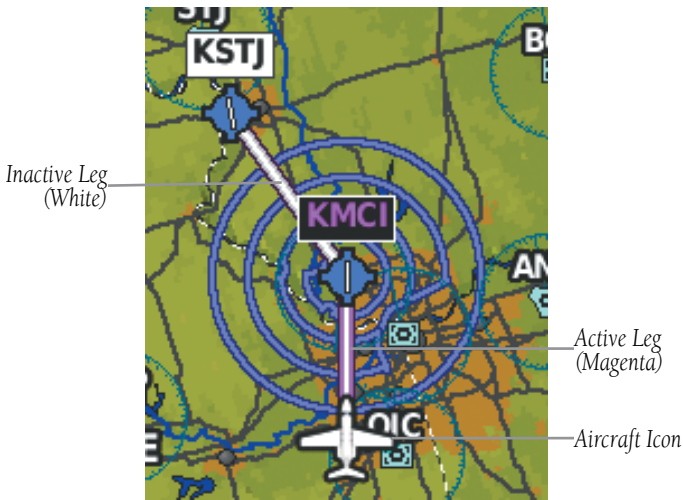

Flight Plan Legs (Navigation Map)

- Overview
- GPS Navigation**
- Flight Planning
- Hazard Avoidance
- Additional Features
- Appendices
- Index

DATA FIELDS

The data fields on the Navigation Map can be independently configured by the user.



Data Fields (Navigation Map)

By default, the Data Fields are set to display Ground Speed (GS), Distance - Next (DIST NEXT), Vertical Speed Required (VSR), and Time En Route - Next (ETE NEXT). These four data fields can be changed to display any of the Data Field Options.

Changing the information shown in the data fields:

- 1 From the **Main Menu**, touch the **Map Icon**.
- 2 Touch the **Menu Icon**.
- 3 Touch the '**Change Data Fields**' menu option.
- 4 Touch the desired Data Field to change. A list of available Data Field Options is displayed.
- 5 Touch the desired Data Field Option.
- 6 Touch the **OK** Icon.



DATA FIELD OPTIONS

- Accuracy
- Altitude
- Bearing (BRG)
- Course to Steer (CTS)
- Desired Track (DTK)
- Distance (Destination) (DIST DEST)
- Distance (Next) (DIST NEXT)
- En Route Safe Altitude (ESA)
- Flight Timer (FLT TIMER)
- Fuel Timer
- Glide Ratio (G/R)
- Ground Speed (GS)
- Ground Track (TRK)
- Minimum Safe Altitude (MSA)
- Next Waypoint (NEXT WPT)
- Sunrise
- Sunset
- Time En Route (Destination) (ETE DEST)
- Time En Route (Next) (ETE NEXT)
- Time of Arrival (Destination) (ETA DEST)
- Time of Arrival (NEXT) (ETA NEXT)
- Time to VNAV (VNAV TIME)
- Time (Local)
- Time (UTC)
- Vertical Speed (VS)
- Vertical Speed Required (VSR)
- Wx (Altimeter) (WX ALTIM)
- Wx (Dew Point) (WX DEW PT)
- Wx (Rel. Humidity) (WX HUMIDITY)
- Wx (Temperature) (WX TEMP)
- Wx (Wind) (WX WIND)

NUMERIC FLIGHT DATA

The numeric flight data can be independently configured by the user.

Accessing numeric flight data:

From the **Main Menu**, touch **Numbers**.

Changing numeric flight data fields:

- 1) From the **Main Menu**, touch **Numbers**.
- 2) Touch the desired data field to change. The available data fields are displayed.
- 3) Touch the desired data field.
- 4) Touch **OK**.

Restoring default numeric flight data:

From the **Main Menu**, touch **Numbers** > **Menu** > **Restore Default**.



Numeric Flight Data

COMPASS ARC

A compass arc appears by default on the Navigation Map. The route line represents the course and the magenta bug indicator (similar to the bug indicator on the HSI) can be set to 'Bearing' (default), 'Course to Steer', a specific heading reference ('User Selected'), or 'Off'.



NOTE: The Compass Arc is hidden while on the ground.



Magenta Bug Indicator

Compass Arc



Compass Arc (Navigation Map)

Displaying/Removing the Compass Arc from the Navigation Map:

- 1) From the **Main Menu**, touch **Map** > **Menu** > **Set Up Map**
- 2) Touch the   buttons to select the '**General**' Category (if necessary).
- 3) Touch the **On/Off** Button in the 'Compass Arc' datafield.

Setting the Compass Arc Bug Indicator:

- 1) From the **Main Menu**, touch **Map** > **Menu** > **Set Bug Indicator** (only available when the compass arc is displayed).
- 2) Touch the desired menu option ('**User Selected**', '**Bearing**', '**Course to Steer**', or '**Off**').

2.2 HSI/PANEL

The HSI/Panel shows GPS-derived data in a graphical format. Keep in mind the differences between the GPS-derived panel and mechanical instruments, as mechanical panel instruments use sensors that provide information different from that derived using GPS.



The Panel shows a graphic Horizontal Situation Indicator (HSI) surrounded by additional indicators.

The graphic HSI depicts the course to the destination or the next waypoint in a flight plan, current ground track, off course error, and a To/From indication. The rotating compass indicates your current ground track.

The course pointer and course deviation needle indicate the course and whether you are on the course. The Bug Indicator can be set to 'Bearing' (default), 'Course to Steer', a specific heading reference ('User Selected'), or 'Off'.

Bearing is the compass direction from the present position to a destination waypoint. Course to Steer is the recommended direction to steer in order to reduce cross-track error and return to the course line.

- Overview
- GPS Navigation
- Flight Planning
- Hazard Avoidance
- Additional Features
- Appendices
- Index

The Course Deviation Indicator, or needle, indicates how far off course, left or right, based on its placement along the course deviation scale.

The course deviation scale appears on the lower right corner of the HSI. There are four CDI Scale settings ('Automatic', '0.25 nm', '1.25 nm', and '5.00 nm'). Three factors are used to determine the distance from the center of the CDI to full left or right limits when the CDI Scale is set to 'Automatic':

- CDI scale = 1.25 - within 30 nm of any airport in the active route.
- CDI scale = 0.25 - on an approach leg or within 2 nm of the FAF or MAP.
- CDI scale = 5.0 - if the previous two conditions do not exist.

Displaying/Removing the HSI/Panel:

- 1) From the **Main Menu**, touch **Map** > **Menu** > **Show/Hide...**
- 2) Touch the **Show/Hide** Button in the 'Panel' datafield.

Changing the CDI scale:

- 1) With the Panel displayed, from the 'Home' Screen, touch **Map** > **Menu** > **Set CDI Scale**.
- 2) Touch the desired CDI Scale ('Automatic', '0.25 nm', '1.25 nm', or '5.00 nm').

SETTING THE BUG INDICATOR

The Bug Indicator can be set from the **Map** option menu.

Setting the Bug Indicator:

- 1) From the **Main Menu**, touch **Map** > **Menu** > **Set Bug Indicator**.
- 2) Touch the desired menu option ('User Selected', 'Bearing', 'Course to Steer', or 'Off').

MANUALLY SETTING A COURSE

Use the 'Set OBS and Hold' menu option from the **Map** option menu to manually set your course to the destination.

Manually setting a course to the destination waypoint:

- 1) From the **Main Menu**, touch the **Map** or the **Active FPL** Icon.
- 2) Touch the **Menu** Icon.

- 3) Touch the **Set OBS and Hold** (only available when navigating a Direct To or Flight Plan).
 - 4) Touch the '+' or '-' Buttons to increase/decrease the value
- Or:**

Touch the Radial Button to enter the desired radial using the keypad and touch the **OK** Icon.



Map Option Menu



Set OBS

Radial Button

Returning to automatic sequencing of route waypoints:

- 1) From the **Main Menu**, touch the **Map** or the **Active FPL** Icon.
- 2) Touch the **Menu** icon.
- 3) Touch the **Release Hold** menu option (only available when navigating a Direct To or Flight Plan).

2.3 VERTICAL NAVIGATION (VNAV)

The VNAV function provides settings for the vertical navigation. These settings create a three-dimensional profile from the present location and altitude to a final (target) altitude at a specified location.

When the VNAV profile is defined, the pilot is informed of the progress by message alerts. The teal bar on the HSI (when displayed) shows the VNAV profile.

The Vertical Navigation feature is only available when navigating a Direct To or flight plan, and the ground speed is greater than 35 knots.

The “Approaching VNAV Profile” message appears one minute prior to the initial descent point. The descent angle locks to prevent changes in speed from altering the profile. The VNAV feature does not take into account any changes in groundspeed that occur during the transition from level flight to descent or climb.

Approaching VNAV profile

At 500 ft above the target altitude, the “Approaching Target Altitude” message appears, the ‘Estimated Time To VNAV’ goes blank, and the VNAV indicator disappears from the HSI.



CAUTION: The aera 795/796 is a VFR navigation tool and should not be used to perform instrument approaches.



CAUTION: VNAV is only a VFR navigation aid and is not intended for instrument approaches.

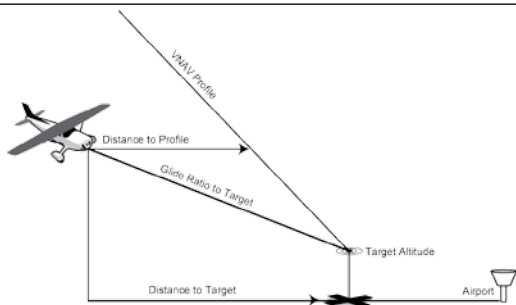

Visual Representation of VNAV

USING THE VNAV FEATURE

Use the VNAV (Vertical Navigation) feature to ensure the aircraft is at the proper altitude. The VNAV Indicator appears on the HSI (when displayed) as a horizontal teal bar. A message appears when approaching the VNAV Profile. When the bar is in the vertical center of the HSI, the aircraft is at the proper altitude for the VNAV Profile.

Configuring a VNAV profile:

- 1) From the **Main Menu**, touch **Tools > VNAV**
- 2) Touch the desired fields ('**Profile**', '**Altitude**', etc) to enter the VNAV profile.
- 3) Touch and hold the **Back** Icon to return to the '**Home**' Screen.



Vertical Navigation

- **Waypoint**—Enter any waypoint along the currently active route as the reference waypoint. The reference waypoint defines the target location.
- **Profile**—Enter the descent rate.
- **Altitude**—Enter the desired reference waypoint altitude. Select 'Above Waypoint' to use field elevation for airports in the Jeppesen database or 'MSL' to specify an exact MSL altitude target.
- **By**—Enter the target location with settings of distance 'Before' or 'After' a reference waypoint. To set a target location at a reference waypoint, enter a distance of zero.
- **VNAV Messages**—Select 'On' or 'Off' to enable/disable VNAV alert messages.

Enabling/disabling the VNAV indicator:

- 1) From the **Main Menu**, touch the **Map** Icon.
- 2) Touch the **Menu** Icon
- 3) Touch the '**Enable VNAV Indicator**' or '**Disable VNAV Indicator**' menu option (only available when the Panel is shown).

Capturing/cancelling VNAV profile:

- 1) Enter a valid VNAV profile (see 'Configuring a VNAV Profile' below) and begin navigation.
- 2) From the **Main Menu**, touch the **Map** Icon.
- 3) Touch the **Menu** Icon
- 4) Touch the '**Capture VNAV Profile**' or '**Cancel Capture**' menu option (only available when navigating a Direct To or Flight Plan).

VNAV Indicator



VNAV Indicator (Panel)

2.4 MAP DISPLAY SETUP

Map displays are used extensively in the aera 795/796 to provide situational awareness in flight. The Navigation Map, Terrain Map, Weather Map, VFR/IFR Charts, and the 3D Vision Map can display the following information:

- Airports, NAVAIDs, airspaces, airways, land data (highways, cities, lakes, rivers, borders, etc.) with names
- Map Pointer information (distance and bearing to pointer, location of pointer, name, and other pertinent information)
- Map range
- Aircraft icon (representing present position)
- Flight plan legs
- User waypoints
- Track vector

- Topography data

MAP ORIENTATION

Maps are shown in one of three different orientation options, allowing flexibility in determining aircraft position relative to other items on the map (North Up) or for determining where map items are relative to where the aircraft is going (Track Up), or desired track up (DTK UP)).

- North Up aligns the top of the map display to north (default setting).
- Track Up aligns the top of the map display to the current ground track.
- Desired Track (DTK) Up aligns the top of the map display to the desired course.





NOTE: *The Map Orientation setting only affects the Navigation Map, Terrain Map, and the 3D Vision Map.*







NOTE: *The Compass Arc will change depending on the Map Orientation selected (i.e., 'North Up' = No Compass Arc displayed, 'Track Up' = Compass Arc displayed, 'Desired Track' = Compass displayed around the aircraft).*

Changing the Map orientation:

- 1) From the **Main Menu**, touch **Map > Menu > Set Up Map**
- 2) Touch the   buttons to select the '**General**' Category (if necessary).
- 3) Touch the 'Orientation' data option button.
- 4) Touch the desired option ('**North Up**', '**Track Up**', or '**DTK Up**').

AIRPORTS, NAVAIDS, CITIES & ROADS

Setting up and customizing airports, NAVAIDs, cities & roads for the navigation map:

- 1) From the **Main Menu**, touch **Map > Menu > Set Up Map**
- 2) Touch the   buttons to select the '**Airport**', '**Navaid**', '**City**', or '**Road**' Category.
- 3) Touch the   buttons to select the desired settings (if available), or touch the Data Option Button to select from a list of options.

AIRWAYS

Low Altitude Airways (or Victor Airways) primarily serve smaller piston-engine, propeller-driven airplanes on shorter routes and at lower altitudes. Airways are eight nautical miles wide and start 1,200 feet above ground level (AGL) and extend up to but not including 18,000 feet mean sea level (MSL). Low Altitude Airways are designated with a "V" before the airway number (hence the name "Victor Airways") since they run primarily between VORs.

High Altitude Airways (or Jet Routes) primarily serve airliners, jets, turboprops, and turbocharged piston aircraft operating above 18,000 feet MSL. Jet Routes start at 18,000 feet MSL and extend upward to 45,000 feet MSL (altitudes above 18,000 feet are called "flight levels" and are described as FL450 for 45,000 feet MSL). Jet Routes are designated with a "J" before the route number.

Low Altitude Airways are drawn in gray. High Altitude Airways are drawn in green. When both types of airways are displayed, high altitude airways are drawn on top of Low Altitude Airways.

When airways are selected for display on the map, the airway waypoints (VORs, NDBs and Intersections) are also displayed.

Displaying/removing airways:

- 1) From the **Main Menu**, touch **Map > Menu > Set Up Map**
- 2) Touch the  buttons to select the '**Navaid**' Category.
- 3) Touch the 'Airways' data option button to select the desired setting ('**Off**', '**Low**', '**High**', or '**Both**').

2.5 WAYPOINTS

Waypoints are predetermined geographical positions (internal database) or pilot-entered positions, and are used for all phases of flight planning and navigation.

Waypoints can be selected by entering the ICAO identifier, entering the name of the facility, or by entering the city name.

The waypoint function allows the pilot to review airport/runway information, frequencies, Airport Directory information (if available), weather information (if available) and Terminal Procedure Charts, by touching the desired tab (**Info**, **Freq**, **WX**, **AOPA**, or **TERPs**). The pilot can manually enter the identifier or the aera 795/796 will choose the most appropriate identifier based on the current position and phase of flight.



Waypoint Information (Info Tab)



WAYPOINT INFORMATION

The following descriptions and abbreviations are used:

- Usage type: Public, Military, or Private
- Runway surface type: Hard, Turf, Sealed, Gravel, Dirt, Soft, Unknown, or Water
- Runway lighting type: No Lights, Part Time, Full Time, Unknown, or PCL Freq (for pilot-controlled lighting)

- COM Availability: TX (transmit only), RX (receive only), PT (part time), * (additional information available)



Selecting an airport for review by identifier, facility name, or city:

- 1) From the **Main Menu**, touch **WPT Info** > **Info** Tab (if necessary).
- 2) Touch the Waypoint Identifier Button (top of page).
- 3) Enter the desired waypoint:
 - a) Touch the  buttons to display the desired search option on the 'Search' Button ('**Search by Identifier**', '**Search by Facility Name**', '**Search by City**', '**Search by Address**' (only available with the optional City Navigator data), or '**Search by Crossroads**' (only available with the optional City Navigator data).
 - b) Touch the 'Search' Button (between the .
 - c) Enter the desired data using the keypad. If duplicate entries are displayed, touch the desired duplicate from the list.
 - d) Touch **OK**.

Or:

 - a) Touch the  buttons to cycle through the waypoint categories ('**Flight Plan Waypoints**', '**Nearest Airports**', or '**Recent Waypoints**').
 - b) Touch the desired waypoint from the list.

Selecting a runway for review by identifier, facility name, or city:

- 1) From the **Main Menu**, touch **WPT Info** > **Info** Tab.
- 2) Touch the Waypoint Identifier Button.
- 3) Enter the desired waypoint:
 - a) Touch the  buttons to display the desired search option on the 'Search' Button ('**Search by Identifier**', '**Search by Facility Name**', '**Search by City**', '**Search by Address**' (only available with the optional City Navigator data), or '**Search by Crossroads**' (only available with the optional City Navigator data).
 - b) Touch the 'Search' Button (between the .
 - c) Enter the desired data using the keypad. If duplicate entries are displayed, touch the desired duplicate from the list.

- d) Touch **OK**.
- Or:**
 - a) Touch the  buttons to cycle through the waypoint categories ('Flight Plan Waypoints', 'Nearest Airports', or 'Recent Waypoints').
 - b) Touch the desired waypoint from the list.
- 4) Touch the desired Runway Button. The map range becomes 0.2 nm and centers on the desired runway. Touch the Runway Button again to return to the previous map range.

WAYPOINT FREQUENCIES

Selecting additional information for a frequency:

- 1) From the **Main Menu**, touch **WPT Info** > **Freq** Tab.
- 2) Touch the frequency denoted with an *.







FREQUENCY ABBREVIATIONS

Communication Frequencies			Navigation Frequencies
Approach *	Control	Pre-Taxi	ILS
Arrival *	CTA *	Radar	LOC
ASOS	Departure *	Ramp	
ATIS	Gate	Terminal*	
AWOS	Ground	TMA *	
Center	Helicopter	Tower	
Class B *	Multicom	TRSA *	
Class C *	Other	Unicom	
Clearance			
* May include Additional Information			

Frequency Abbreviations





WAYPOINT WEATHER INFORMATION

Viewing airport weather information:

- 1) From the **Main Menu**, touch the **WPT Info** Icon.
- 2) Enter the desired waypoint:
 - a) Touch the   buttons to display the desired search option on the 'Search' Button ('**Search by Identifier**', '**Search by Facility Name**', '**Search by City**', '**Search by Address**' (only available with the optional City Navigator data), or '**Search by Crossroads**' (only available with the optional City Navigator data)).
 - b) Touch the 'Search' Button (between the  ).
 - c) Enter the desired data using the keypad. If duplicate entries are displayed, touch the desired duplicate from the list.
 - d) Touch **OK**.
- Or:**
 - a) Touch the   buttons to cycle through the waypoint categories ('**Flight Plan Waypoints**', '**Nearest Airports**', or '**Recent Waypoints**').
 - b) Touch the desired waypoint from the list.
- 3) Touch the **WX** Tab.

AIRPORT DIRECTORY WAYPOINT INFORMATION

Viewing Airport Directory information:

- 1) From the **Main Menu**, touch the **WPT Info** Icon.
- 2) Enter the desired waypoint:
 - a) Touch the   buttons to display the desired search option on the 'Search' Button ('**Search by Identifier**', '**Search by Facility Name**', '**Search by City**', '**Search by Address**' (only available with the optional City Navigator data), or '**Search by Crossroads**' (only available with the optional City Navigator data)).
 - b) Touch the 'Search' Button (between the  ).
 - c) Enter the desired data using the keypad. If duplicate entries are displayed, touch the desired duplicate from the list.

d) Touch **OK**.

Or:

a) Touch the  buttons to cycle through the waypoint categories ('**Flight Plan Waypoints**', '**Nearest Airports**', or '**Recent Waypoints**').

b) Touch the desired waypoint from the list.

3) Touch the **AOPA** Tab.

VIEWING CHART INFORMATION BY IDENTIFIER

Viewing Chart information:

1) From the **Main Menu**, touch the **WPT Info** Icon.

2) Enter the desired waypoint:

a) Touch the  buttons to display the desired search option on the 'Search' Button ('**Search by Identifier**', '**Search by Facility Name**', '**Search by City**', '**Search by Address**' (only available with the optional City Navigator data), or '**Search by Crossroads**' (only available with the optional City Navigator data).

b) Touch the 'Search' Button (between the .

c) Enter the desired data using the keypad. If duplicate entries are displayed, touch the desired duplicate from the list.

d) Touch **OK**.

Or:

a) Touch the  buttons to cycle through the waypoint categories ('**Flight Plan Waypoints**', '**Nearest Airports**', or '**Recent Waypoints**').

b) Touch the desired waypoint from the list.

3) Touch the **TERPs** Tab.

4) Touch the  buttons to cycle through the available Charts.

NEAREST INFORMATION

The aera 795/796 provides a Nearest function which gives the pilot quick access to nearest airport, weather, VOR, NDB, intersection, VRP (Atlantic Unit), user waypoint, city, ARTCC, FSS, and airspace information. If there are none available, “None Within 200 NM” is displayed.



The Nearest functions contain the following information.

- Airport—city/facility, identifier, bearing, distance, length of the longest runway, and common traffic advisory (CTAF) or tower frequency.
- Airport WX (Airport Weather)—identifier, bearing, distance, METAR text (aera 796 only), and ATIS, AWOS, or ASOS frequency.
- VOR (VHF Omnidirectional Radio Beacon)—facility name, identifier, facility type (symbol), bearing, distance, and frequency.
- NDB (Non Directional Beacons)—identifier, facility, type (symbol), bearing, distance, and frequency.
- Intersection—identifier, bearing, and distance.
- VRP (Visual Reporting Point) (Atlantic Unit Only)—identifier, bearing, and distance.
- USR WPT (User Waypoints)—name, bearing, and distance.
- City—name, bearing, and distance.
- ARTCC (Air Route Traffic Control Center)—bearing, distance, and a list of frequencies.
- FSS (Flight Service Station)—name, bearing, distance, VOR (if applicable), and a list of frequencies.
- Airspace—name, time to entry (while in flight), and status.

Viewing nearest information:

- 1) Touch **NRST**.
- 2) Touch the desired Nearest Icon (**Airport, Airport WX, VOR, NDB, Intersection, VRP, User WPT, City, ARTCC, FSS, or Airspace**).
- 3) Touch the desired nearest option from the list twice for additional information.

Or:

If viewing Nearest ARTCCs or FSSs, touch the   buttons to cycle through the list.

4) Touch the **Back** Icon to return to the second level Nearest Icons.

Or:

Touch **Direct To** ➔, then the Activate Button to navigate Direct-to the selected waypoint.



Nearest Airports List

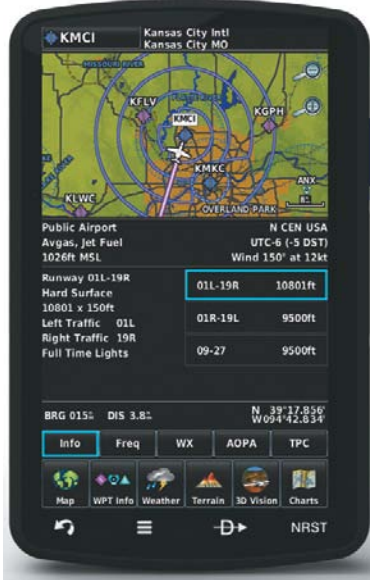

Additional Airport Information

NEAREST AIRPORT CRITERIA

The pilot can define the minimum runway length and surface type used when determining the 15 nearest airports to display. A minimum runway length and/or surface type can be entered to prevent airports with small runways or runways that are not appropriately surfaced from being displayed. Default settings are 0 feet (or meters) for runway length and "Any" for runway surface type. Private airports and Heliports can also be included.

The Nearest Airports Option Menu also allows the pilot to choose between displaying the facility names and city names.







Setting nearest airport criteria:

Refer to Section 1.7 'Airport Criteria Settings'.

TEXTUAL WEATHER INFORMATION

Textual weather information can be viewed several different ways.

Viewing textual airport weather information:

- 1) From the **Main Menu**, touch the **WPT Info** Icon.
 - 2) Enter the desired waypoint:
 - a) Touch the   buttons to display the desired search option on the 'Search' Button ('**Search by Identifier**', '**Search by Facility Name**', '**Search by City**', '**Search by Address**' (only available with the optional City Navigator data), or '**Search by Crossroads**' (only available with the optional City Navigator data)).
 - b) Touch the 'Search' Button (between the  ).
 - c) Enter the desired data using the keypad. If duplicate entries are displayed, touch the desired duplicate from the list.
 - d) Touch **OK**.
- Or:**
- a) Touch the   buttons to cycle through the waypoint categories ('**Flight Plan Waypoints**', '**Nearest Airports**', or '**Recent Waypoints**').
 - b) Touch the desired waypoint from the list.
- 3) Touch the **WX** Tab.
 - 4) If desired touch **Menu** > **Show Raw Text/Show Decoded Text** to switch from raw data to decoded data.
- Or:**
- 1) Touch **NRST** > **Airport WX**.
 - 2) Touch the desired Nearest Airport Weather from the list.
- Or:**
- 1) From the **Main Menu**, touch the **Weather** > **METAR**.
 - 2) Touch the desired METAR flag.
 - 3) Touch the Map Feature Button with the desired identifier displayed (refer to 'Map Panning' in the Overview Section for more information). The weather information is displayed.

- 4) If desired touch **Menu > Show Raw Text/Show Decoded Text** to switch from raw data to decoded data.

Or:

- 1) From the **Main Menu**, touch the **Map** Icon.
- 2) Touch the desired METAR Flag (If the METAR flags are not displayed, adjust the settings from the 'Set Up Map' menu option).
- 3) Touch the Map Feature Button with the desired identifier displayed (refer to 'Map Panning' in the Overview Section for more information). The weather information is displayed.
- 4) If desired touch **Menu > Show Raw Text/Show Decoded Text** to switch from raw data to decoded data.

METAR Selected

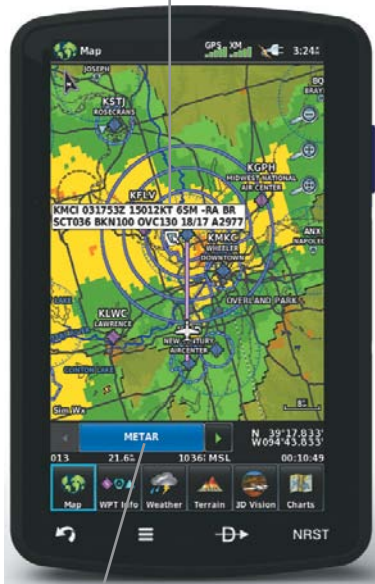

Map Feature Button

Weather Information

ACCESSING ADDITIONAL INFORMATION

In addition to airport and weather information, additional information for VORs, NDBs, Intersections, User Waypoints, Cities, ARTCCs, FSSs, and Airspace can be viewed by touching the **WPT Info** Icon, the **NRST** Icon, or by using the Map Pointer.

Additional Information									
	Airport	VOR	NDB	Intersection	User Wpt	City	ARTCC	FSS	Airspace
Identifier	+	+	+	+	+				
Frequency	+	+	+				+	+	+
Name	+	+	+	+	+				+
City	+	+	+			+			+
State	+	+	+			+			
Type	+	+	+						
Morse Code		+	+						
Radial		+							
Region	+	+	+	+	+				
Bearing	+	+	+	+	+	+	+	+	
Distance	+	+	+	+	+	+	+	+	+
Lat/Long	+	+	+	+	+	+			
Elevation (MSL)	+				+				
Fuel Available	+								
Time Zone (UTC Offset)	+								
Runway Information	+								
AOPA	+								
Weather	+								
Controlling Agency									+
Vertical Boundaries									+
Class									+

INTERSECTIONS

Intersection information can be viewed using the Waypoint Information function, the Nearest function, or the Map Panning function.

The Nearest Intersection function can be used to quickly find an intersection close to the flight path. The list only includes Intersections that are within 200nm.

Select an intersection:

- 1) From the **Main Menu**, touch the **WPT Info** Icon.
- 2) Touch the Waypoint Identifier Field to enter the desired intersection. Refer to the Overview Section on 'Data Entry' for more information.

Or:

- 1) Touch **NRST > Intersection**.
- 2) Touch the desired Nearest Intersection twice. The intersection information is displayed.
- 3) If desired, touch **Menu > Show Map** or **Show Chart**.

Or:

- 1) From the **Main Menu**, touch the **Map** Icon.
- 2) Touch the desired Intersection on the map.
- 3) Touch the Map Feature Button with the desired intersection displayed (refer to the Overview Section on 'Map Panning' for more information). The intersection information is displayed.

NDBs

NDB information can be viewed using the Waypoint Information function, the Nearest function, or the Map Panning function.

The Nearest NDB function can be used to quickly find a NDB close to the flight path. The list only includes NDBs that are within 200nm.

Select an NDB:

- 1) From the **Main Menu**, touch the **WPT Info** Icon.
- 2) Touch the Waypoint Identifier Field to enter the desired NDB. Refer to the Overview Section on 'Data Entry' for more information.

Or:

- 1) Touch **NRST > NDB**.
- 2) Touch the desired Nearest NDB from the list. The NDB information is displayed.
- 3) If desired, touch **Menu > Show Map** or **Show Chart**.

Or:

- 1) From the **Main Menu**, touch the **Map** Icon.
- 2) Touch the desired NDB on the map.
- 3) Touch the Map Feature Button with the desired NDB displayed (refer to the Overview Section on 'Map Panning' for more information). The NDB information is displayed.

VORs

VOR information can be viewed using the Waypoint Information function, the Nearest function, or the Map Panning function.

The Nearest VOR function can be used to quickly find a VOR close to the flight path. The list only includes VORs that are within 200nm.

Localizer information cannot be viewed for the VOR. If a VOR station is combined with a TACAN station it is listed as a VORTAC, and if it includes only DME it is displayed as VOR-DME.

Select an VOR:

- 1) From the **Main Menu**, touch the **WPT Info** Icon.
- 2) Touch the Waypoint Identifier Field to begin entering the desired VOR. Refer to the Overview Section on 'Data Entry' for more information.

Or:

- 1) Touch **NRST > VOR**.
- 2) Touch the desired Nearest VOR from the list. The Nearest VOR information is displayed.
- 3) If desired, touch **Menu > Show Map** or **Show Chart**.

Or:

- 1) From the **Main Menu**, touch the **Map** Icon.
- 2) Touch the desired VOR on the map.

- 3) Touch the Map Feature Button with the desired VOR displayed (refer to the Overview Section on 'Map Panning' for more information). The VOR information is displayed.

USER WAYPOINTS

The aera 795/796 can create and store up to 3,000 user-defined waypoints. Once a waypoint has been created, it can be renamed, deleted, or moved.

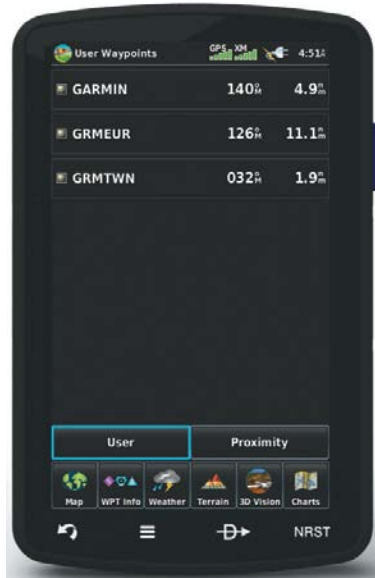

User Waypoints

Creating user waypoints:

- 1) Touch the desired point on the map.
- 2) Touch **Menu > Create Waypoint**
- 3) Enter the desired user waypoint name (up to 20 characters). Refer to the Overview Section on 'Data Entry' for more information.
- 4) Touch the **OK** Icon.

Selecting and viewing nearest user waypoints:

- 1) Touch **NRST > User WPT**.
- 2) Touch the desired User Waypoint twice to display the User Waypoint information.

Editing or renaming a user waypoint:

- 1) From the **Main Menu**, touch **Tools** > **User WPT**.
- 2) Touch the desired User Waypoint.
- 3) Touch **Menu**.
- 4) Touch the '**Edit Waypoint**' menu option.
- 5) Touch the desired field to edit:
- 6) Edit the desired information and touch **OK**.

Deleting user waypoints:

- 1) From the **Main Menu**, touch **Tools** > **User WPT**.
- 2) Delete a single waypoint, delete all waypoints, delete by symbol or delete by distance:
 - a) Touch the desired User Waypoint.
 - b) Touch **Menu**.
 - c) Touch the '**Delete Waypoint**' menu option. The confirmation window will appear.

Or:

 - a) Touch the **Menu** Icon.
 - b) Touch the '**Delete All**' menu option. The confirmation window will appear.
 - c) Touch the **Menu** Icon.
 - b) Touch the '**Delete by Symbol**' menu option.
 - c) Touch the desired symbol to delete. The symbol will be highlighted blue.
 - d) Touch **OK**. The confirmation window will appear.

Or:

 - a) Touch the **Menu** Icon.
 - b) Touch the '**Delete by Distance**' menu option.
 - c) If desired, touch the **From** Field and touch '**Current Location**' (default), '**Use Identifier**', or '**Use Map**' from the option menu.
 - d) If desired, touch the '**Less Than/More Than**' Button, and touch the **Distance** Field to enter the desired distance.

- e) Touch the **OK** icon. The confirmation window will appear.
- 3) Touch **Yes**.

CITIES

City information can be viewed using the Waypoint Information function, the Nearest function, or the Map Panning function.

The Nearest City function can be used to quickly find a city near the aircraft's current position. The list only includes cities that are within 200nm.

Select a city:

- 1) Touch **NRST > City**.
- 2) Touch the desired Nearest City from the list.

Or:



- 1) From the **Main Menu**, touch **Map**.
- 2) Touch the desired city symbol on the map.
- 3) Touch the Map Feature Button with the desired city displayed (refer to the Overview Section on 'Map Panning' for more information). The city information is displayed.

ARTCC

ARTCC information can be viewed using the Nearest function.

The Nearest ARTCC function can be used to quickly find a ARTCC close to the flight path. The list only includes ARTCC that are within 200nm.

Select an ARTCC:

- 1) Touch **NRST > ARTCC**.
- 2) Touch the   buttons to cycle through the list. The associated bearing, distance, and frequencies are displayed.



FSS

FSS information can be viewed using the Nearest function.

The Nearest FSS function can be used to quickly find a FSS close to the flight path. The list only includes FSS that are within 200nm.

FSS frequencies and phone numbers can also be found using the **AOPA** Tab when reviewing information for an airport. Refer to the Additional Features Section on 'AOPA' for more information.

Select an FSS:

- 1) Touch **NRST > FSS**.
- 2) Touch the   buttons to cycle through the list. The associated bearing, distance, and frequencies are displayed.

AIRSPACE

The Nearest Airspace function and Airspace Alerts provide information about airspaces and the location of the aircraft in relationship to them. The Nearest Airspace function can be used to quickly find airspaces close to the flight path.

The Nearest Airspace function displays the class of airspace, controlling agency, vertical boundaries, and status.

Selecting and viewing nearest airspaces:

- 1) Touch **NRST > Airspace**.
- 2) Touch the desired airspace from the list (the Nearest Airspaces list is not available on the ground). The airspace information is displayed.
- 3) If desired, touch '**Frequencies**' to view frequencies associated with that airspace.



Nearest Airspace

AIRSPACE ALERT MESSAGES

If airspace alarms are set to 'On' (default is 'Off'), the aera 795/796 will display a message which includes the airspace name, time to entry (if applicable), and status. Touch the message to acknowledge it.



NOTE: *Airspace Alert Messages do not work while on the ground.*

There are four types of status information:

- Ahead—Projected to enter the airspace within the next 10 minutes or less
- Near—Within two nautical miles of an airspace but not projected to enter it.
- Near & Ahead—Project to enter the airspace within two nautical miles.
- Inside Airspace—Within the boundaries of the airspace.

Airspace alert setup:

- 1) From the **Main Menu**, touch **Tools** > **Setup** > **SUA Alarms**.
- 2) Touch the desired **On/Off** Button(s).

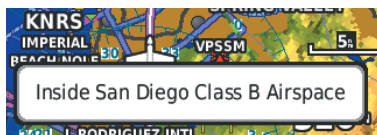

Airspace Alert Message

SMART AIRSPACE

Smart Airspace shows airspace at and immediately surrounding the aircraft's current altitude in bold. Airspaces at all other altitudes are de-emphasized.

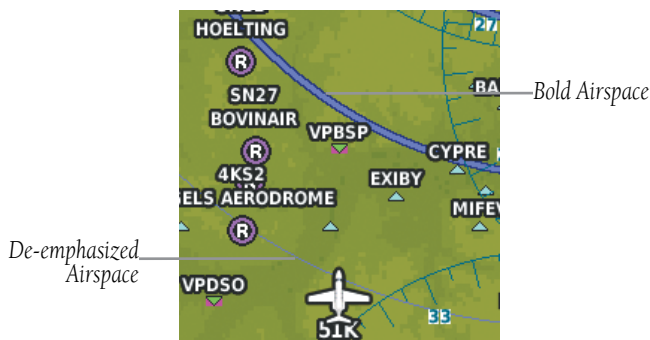

Smart Airspace

Smart Airspace setup:

- 1) From the **Main Menu**, touch **Map** > **Menu** > **Set Up Map**.
- 2) Touch the  buttons to select the **Airspace** Category.
- 3) Touch the 'Smart Airspace' **On/Off** Button.

2.6 DIRECT-TO NAVIGATION

The Direct-to method of navigation, initiated by pressing the **Direct To** ➔ icon is quicker to use than a flight plan when the desire is to navigate to a single point such as a nearby airport.

Once a direct-to is activated, the aera 795/796 establishes a point-to-point course line from the present position to the selected direct-to destination. Course guidance is provided until the direct-to is replaced with a new direct-to or flight plan, or cancelled.



Direct -to
Direct To (Activate)

Direct To (Stop Navigation)

Entering a waypoint identifier, facility name, or city as a direct-to destination:

- 1) Touch the **Direct To** ➔ icon.
- 2) Touch **Menu > Resume Navigation** (if available).

Or:

- a) Touch the '**Search by Identifier**', '**Search by Facility Name**', or '**Search by City**' fields.'

b) Enter the desired Identifier, Facility Name, or City using the keypad. Refer to the Overview Section on 'Data Entry' for more information.

c) Touch the **OK** Icon.

Or:

a) Touch '**More...**'.

b) Touch the   buttons to view '**Flight Plan Waypoints**', '**Nearest Airports**', or '**Recent Waypoints**'.

c) Touch the desired waypoint from the list.

3) Touch the **Activate** Icon (if necessary).

Selecting a nearby airport as a direct-to destination:

1) Touch **NRST > Airport**.

2) Touch the desired nearest airport.

3) Touch **Direct To** .

4) Touch **Activate**.

Selecting a waypoint as a direct-to destination using the pointer:

1) With the Navigation Map, Terrain Map, Weather Map, 3D Vision Map, or VFR/IFR Charts displayed, activate the map pointer by touching the desired waypoint. If no airport, NAVAID, or User Waypoint exists at the desired location, a temporary waypoint named 'Map Pointer' is automatically created at the location of the map pointer.

2) Touch **Direct** .

3) Touch **Activate**.

Canceling a direct-to:

Touch **Direct To**  > **Stop Nav**.

Or:

From the **Main Menu**, touch the **Active FPL > Menu > Stop Navigation**

SECTION 3 FLIGHT PLANNING

3.1 INTRODUCTION

Flight planning on the aera 795/796 consists of building a flight plan by entering waypoints one at a time and inserting approaches as needed.

Up to 50 flight plans with up to 300 waypoints each can be created and stored in memory. One flight plan can be activated at a time and becomes the active flight plan. The active flight plan is erased when the destination is reached and the system is turned off. When storing flight plans with an approach, the aera 795/796 uses the waypoint information from the current database to define the waypoints. If the database is changed or updated, the aera 795/796 automatically updates the information if the procedure has not been modified. If an approach is no longer available, the procedure is deleted from the affected stored flight plan(s), and an alert is displayed.

Whenever an approach is loaded into the active flight plan it replaces the destination airport with a sequence of waypoints for the selected approach. The airport must have a published instrument approach and only the final course segment (usually from final approach fix to missed approach point) of the published approach is available in the aera 795/796.

DATA FIELDS

The Active and Saved Flight Plan Data Fields can be changed by touching the Data Field Buttons at the top of the flight plan.

Changing the information shown in the flight plan data fields:

- 1) From the **Main Menu**, touch the **Active FPL** Icon.
Or:
 - a) From the **Main Menu**, touch **FPL List**.
 - b) Touch the desired Saved Flight Plan from the list. An option menu appears.
 - c) Touch the '**Review Flight Plan**' menu option.
- 2) Touch the desired Data Field Button at the top of the Flight Plan.
- 3) Touch the desired Data Field. The currently selected Data Field is outlined blue.
- 4) Touch the **OK** Icon.
- 5) If desired, repeat Steps 2-4 for the remaining Data Field.



Flight Plan Data Fields

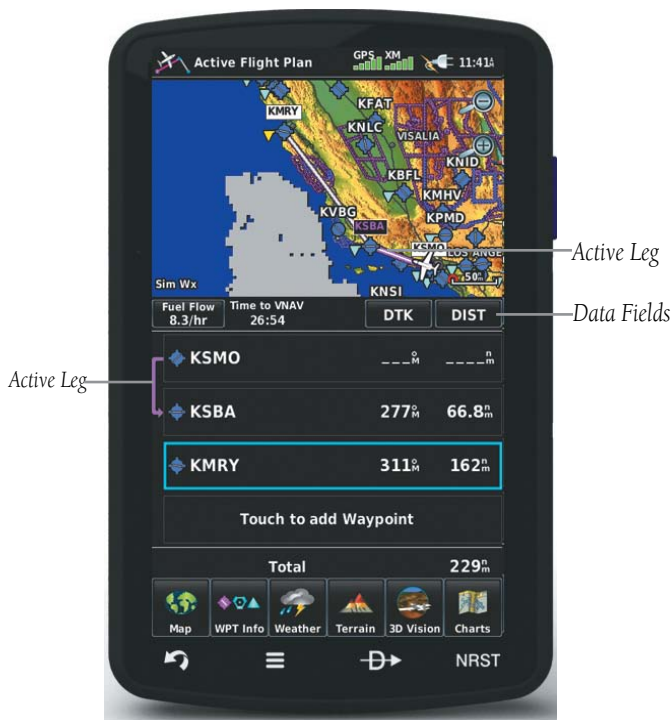

3.2 FLIGHT PLAN CREATION

The active flight plan is the flight plan to which the aera 795/796 is currently providing guidance, and is shown on the navigation maps. Stored flight plans are flight plans available for activation (becomes the active flight plan).



Active Flight Plan

Creating an active flight plan:

- 1) From the **Main Menu**, touch the **Active FPL** Icon.
- 2) Touch the '**Touch to add Waypoint**' Button.
- 3) Enter the desired waypoint:
 - a) Touch the   buttons to display the desired search option on the 'Search' Button ('**Search by Identifier**', '**Search by Facility Name**', '**Search by City**', '**Search by Address**' (only available with the optional City Navigator data), or '**Search by Crossroads**' (only available with the optional City Navigator data)).

- b) Touch the 'Search' Button (between the .
- c) Enter the desired data using the keypad. If duplicate entries are displayed, touch the desired duplicate from the list.
- d) Touch **OK**.

Or:

- a) Touch the  buttons to cycle through the waypoint categories ('**Flight Plan Waypoints**', '**Nearest Airports**', or '**Recent Waypoints**').

- b) Touch the desired waypoint from the list.

- 4) Repeat Steps 2-4 to enter each additional waypoint.

Creating a stored flight plan:

- 1) From the **Main Menu**, touch **FPL List** > **Menu** > **New Flight Plan**.

- 2) Touch the '**Touch to add Waypoint**' Button.

- 3) Enter the desired waypoint:

- a) Touch the  buttons to display the desired search option on the 'Search' Button ('**Search by Identifier**', '**Search by Facility Name**', '**Search by City**', '**Search by Address**' (only available with the optional City Navigator data), or '**Search by Crossroads**' (only available with the optional City Navigator data)).

- b) Touch the 'Search' Button (between the .

- c) Enter the desired data using the keypad. If duplicate entries are displayed, touch the desired duplicate from the list.

- d) Touch **OK**.

Or:

- a) Touch the  buttons to cycle through the waypoint categories ('**Flight Plan Waypoints**', '**Nearest Airports**', or '**Recent Waypoints**').







- b) Touch the desired waypoint from the list.

- 4) Repeat Steps 2-4 to enter each additional waypoint.

ADDING WAYPOINTS TO AN EXISTING FLIGHT PLAN

Waypoints can be added to the active flight plan or any stored flight plan. Choose the flight plan, select the desired point of insertion, enter the waypoint, and it is added in front of the selected waypoint. Flight plans are limited to 300 waypoints (including approach waypoints).

Adding a waypoint to an active or stored flight plan:

- 1) With an active or saved flight plan displayed, touch the desired point of insertion. The new waypoint will be added in front of the selected waypoint. An option menu will appear.
 - 2) Touch the '**Insert Waypoint**' menu option.
 - 3) Enter the desired waypoint:
 - a) Touch the   buttons to display the desired search option on the 'Search' Button ('**Search by Identifier**', '**Search by Facility Name**', '**Search by City**', '**Search by Address**' (only available with the optional City Navigator data), or '**Search by Crossroads**' (only available with the optional City Navigator data)).
 - b) Touch the 'Search' Button (between the  ).
 - c) Enter the desired data using the keypad. If duplicate entries are displayed, touch the desired duplicate from the list.
 - d) Touch **OK**.
- Or:**
- a) Touch the   buttons to cycle through the waypoint categories ('**Flight Plan Waypoints**', '**Nearest Airports**', or '**Recent Waypoints**').
 - b) Touch the desired waypoint from the list.

Loading an approach procedure into a stored flight plan:

An Approach Procedure can be loaded at any airport that has an approach available. Only one approach can be loaded at a time in a flight plan. The route for a selected approach is defined by designating transition waypoints.

- 1) With an active flight plan displayed, touch the **Menu** Icon
- 2) Touch the '**Select Approach**' menu option. A vertical list of available approaches is displayed.
- 3) Touch the desired approach. The designated transition waypoints are added to the flight plan.

3.3 FLIGHT PLAN STORAGE

The aera 795/796 can store up to 50 flight plans. The active flight plan is erased when another flight plan is activated. Details about each stored flight plan can be viewed using the Flight Plan List function.

Viewing information about a stored flight plan:

- 1) From the **Main Menu**, touch **FPL List**
- 2) Touch the desired saved flight plan. An option menu is displayed.
- 3) Touch the '**Review Flight Plan**' menu option.

Storing an active flight plan:

- 1) With the Active Flight Plan displayed, touch the **Menu** Icon.
- 2) Touch the '**Save Flight Plan**' menu option. A confirmation window appears.
- 3) Touch **Yes**. A copy of the flight plan is stored in the next available position in the Flight Plan List.

3.4 FLIGHT PLAN ACTIVATION

Activating a stored flight plan erases the active flight plan and replaces it with a copy of the flight plan being activated. Inverting a stored flight plan reverses the waypoint order, erases the active flight plan, and replaces it with the flight plan being activated (the stored flight plan is not changed).

Activating a stored flight plan:

- 1) From the **Main Menu**, touch **FPL List**
- 2) Touch the desired saved flight plan. An option menu is displayed.
- 3) Touch the '**Activate Flight Plan**' menu option. A confirmation window appears.
- 4) Touch **Yes**.

Activating a Flight Plan Leg:

- 1) From the **Main Menu**, touch the **Active FPL** Icon.
- 2) While navigating an active flight plan, touch the desired leg to be activated. An option menu automatically appears.

- 3) Touch the 'Activate Leg' menu option.
- 4) Touch **Yes**.

3.5 FLIGHT PLAN EDITING

EDITING SPEED AND FUEL FLOW

Adjusting the Flight Plan cruise speed and fuel flow:

From the **Main Menu**, touch **Active FPL**, and touch the **Fuel Flow** Button to enter the desired fuel flow using the keypad.

Or:

- 1) From the **Main Menu**, touch **Tools > Profile**.
- 2) If necessary, touch the Aircraft Button, and touch the desired aircraft from the vertical list.
- 3) Touch the **Cruise Speed** and/or **Fuel Flow** Fields to enter the desired value using the keypad or by touching the '+' or '-' Buttons.

Fuel Flow Button

Aircraft Button



Speed & Fuel Flow

COPYING FLIGHT PLANS

The aera 795/796 allows copying a flight plan into a new flight plan memory slot, allowing editing, etc., without affecting the original flight plan. This can be used to duplicate an existing stored flight plan for use in creating a modified version of the original stored flight plan.

Copying a stored flight plan:

While reviewing the desired Stored Flight Plan, touch **Menu > Copy Flight Plan > Yes**.

DELETING FLIGHT PLANS

Individual or all stored flight plans can be deleted from the aera 795/796 memory.

Deleting a stored flight plan:

While reviewing the desired Stored Flight Plan, touch the **Menu > Delete Flight Plan > Yes**

Or:

With the Flight Plan List displayed, touch the desired flight plan to delete, and touch **Delete Flight Plan > Yes**.

Deleting all stored flight plans:

From the **Main Menu**, touch **FPL List > Menu > Delete All > Yes**.

Deleting the Active Flight Plan:

From the **Main Menu**, touch **Active FPL > Menu > Stop Navigation**.

Deleting an individual waypoint from the active flight plan:

- 1) From the **Main Menu**, touch the **Active FPL** Icon.
- 2) While navigating an active flight plan, touch the waypoint to be deleted. An option menu appears.
- 3) Touch the '**Remove Waypoint**' menu option. A confirmation window appears.
- 4) Touch **Yes**.

Deleting an individual waypoint from a saved flight plan:

- 1) From the **Main Menu**, touch **FPL List**.
- 2) Touch the desired saved flight plan. An option menu is displayed.
- 3) Touch the '**Review Flight Plan**' menu option.
- 4) Touch the desired waypoint to be deleted. An option menu appears.
- 5) Touch the '**Remove Waypoint**' menu option. A confirmation window appears.
- 6) Touch **Yes**.



NOTE: The changes made to the active flight plan affect navigation as soon as they are entered. Editing the active flight plan does not affect any saved flight plans. Waypoints in the final approach segment (such as the FAF or MAP) can not be deleted individually.

INVERTING A FLIGHT PLAN

Any flight plan may be inverted (reversed) for navigation back to the original departure point.

Inverting the active flight plan:

From the **Main Menu**, touch **Active FPL > Menu > Invert Flight Plan > Yes**.

Inverting a saved flight plan:

- 1) From the **Main Menu**, touch **FPL List**
- 2) Touch the desired saved flight plan. An option menu is displayed.
- 3) Touch the '**Review Flight Plan**' menu option.
- 4) Touch the **Menu** Icon
- 5) Touch the '**Invert Flight Plan**' menu option. A confirmation window appears.
- 6) Touch **Yes**.

IMPORTING/EXPORTING FLIGHT PLANS

Importing flight plans:

- 1) Insert an SD Card containing one or more flight plans into the SD Card Slot.
- 2) From the **Main Menu**, touch **FPL List** > **Menu** > **Import Flight Plans**
- 3) Touch the desired flight plan(s) to import.

Exporting flight plans:

- 1) Insert an SD Card into the SD Card Slot.
- 2) From the **Main Menu**, touch **FPL List**
- 3) Touch the desired flight plan to export (a list of menu options appears).
- 4) Touch the '**Export Flight Plan**' menu option.

3.6 APPROACHES



WARNING: *The aera 795/796 is not designed to be independently used for flight into instrument meteorological conditions (IMC) or other conditions in which aircraft control is based solely upon flight instruments. The approaches provided are for monitoring purposes only. Only the final course segment (final approach fix (FAF) to missed approach point (MAP)) of the published approach is available for monitoring.*

An approach can be loaded at any airport that has one available, and provides guidance for non-precision and precision approaches to airports with published instrument approach procedures. Only one approach can be loaded at a time in a flight plan. If an approach is loaded when another approach is already in the active flight plan, the new approach replaces the previous approach. Only the final course segment (Final Approach Fix (FAF) to Missed Approach Point (MAP)) of the published approach is available for monitoring.

Whenever an approach is selected the aera 795/796 automatically activates the approach. The procedure is added to the end of the flight plan and immediately begins to provide guidance to the first waypoint in the approach.



Approach Selection

SELECTING AN APPROACH

When selecting an approach, it replaces the destination airport with the sequence of waypoints for the selected approach. Keep in mind that the airport must have a published approach (GPS, RNAV, VOR, NDB, localizer, or ILS) and only the final course segment (final approach fix to missed approach point) of the published approach is available in the aera 795/796. If the airport does not have a published approach, the 'Select Approach' menu option is not available.

An approach can be selected using the Direct-to, Active Flight Plan, and the Saved Flight Plan functions.

Selecting an approach from the active or saved flight plan:

- 1) From the **Main Menu**, touch the **Active FPL** Icon.
 - Or:**
 - a) From the **Main Menu**, touch the **FPL List** Icon.
 - b) Touch the desired Saved Flight Plan from the list. An option menu appears.
 - c) Touch the **'Review Flight Plan'** menu option.

- 2) With the flight plan displayed, touch the **Menu** Icon.
- 3) Touch the '**Select Approach**' menu option (only available if the destination airport has a published approach). A vertical list of available approaches is displayed.
- 4) Touch the desired approach. The 'Vectors to Final?' window appears.
- 5) Touch '**Yes**' or '**No**'. The procedure is added to the end of the flight plan. If activating an approach from the Active Flight Plan, the aera 795/796 immediately begins to provide guidance to the first waypoint in the approach.

Selecting an approach using the Direct To function:

- 1) Touch **Direct To** > **Menu** .
- 2) Touch the '**Select Approach**' menu option (only available when navigating a flight plan. A vertical list of available approaches is displayed.
- 3) Touch the desired approach. The 'Vectors to Final?' window appears.
- 4) Touch '**Yes**' or '**No**'. The procedure is added to the end of the Active Flight Plan and the aera 795/796 immediately begins to provide guidance to the first waypoint in the approach.

Resuming the Flight Plan after selecting an approach:

Whenever an approach is selected the aera 795/796 automatically activates the approach. The procedure is added to the end of the flight plan and immediately begins to provide guidance to the first waypoint in the approach. Follow the steps below to resume the flight plan after activating the approach.

From the **Main Menu**, touch **Active FPL** > **Menu** > **Resume Navigation**.

Or:

Touch **Direct To** ➤ > **Resume Nav**

Or:

Touch **Direct To** > **Menu** > **Resume Navigation**.

Removing an approach:

- 1) Using a flight plan with an approach loaded, touch the **Active FPL** Icon on the **Main Menu**.
- Or:**

- a) From the **Main Menu**, touch **FPL List**.
 - b) Touch the Saved Flight Plan with an approach loaded. An option menu appears.
 - c) Touch the '**Review Flight Plan**' menu option.
- 2) Press the **Menu** Icon.
 - 3) Touch the '**Remove Approach**' menu option (only available if an approach is loaded).

ACTIVATING VECTORS-TO-FINAL

After an approach has been activated, the '**Activate Vectors-to-Final**' menu option is used when being vectored to the final approach course by Air Traffic Control (ATC).

When Vectors-to-Final are activated, the aera 795/796 creates an extension of the final course, beyond the final approach waypoint in the database (final approach fix [FAF]). A Vector to Final symbol appears beside the first approach waypoint in the Active Flight Plan.

Activating/Canceling Vectors-to-Final:

- 1) From the **Main Menu**, touch the **Active FPL** Icon.
- 2) While navigating an Active Flight Plan (with an approach activated), touch the **Menu** Icon.
- 3) Touch the '**Activate Vectors-to-Final**' or '**Cancel Vectors-to-Final**' menu option.

The aera 795/796 provides no guidance to the inbound course. The course deviation needle on the graphic HSI remains off-center until established on the final approach course. The map shows an extension of the final approach course using a bold magenta line.

If Vectors-to-Final are not activated, the aera 795/796 creates a straight-line course directly to the first waypoint in the approach.

Loading the approach cancels the Direct-to and initiates a route to the FAF.

Blank Page

SECTION 4 HAZARD AVOIDANCE

4.1 SIRIUSXM® WEATHER (aera 796)



NOTE: You *MUST* have a GXM 40 smart antenna connected to your aera 796 and a subscription to SiriusXM Weather to use SiriusXM Weather features.



NOTE: The weather products displayed on the aera 796 are dependant on the SiriusXM Weather Data Service Package (Aviator LT, Aviator, Aviator Pro) purchased.

ACTIVATING SERVICES

Before SiriusXM Satellite Weather can be used, the service must be activated. Service is activated by providing SiriusXM Satellite Radio with a Radio ID unique to the GXM 40 antenna.

SiriusXM Satellite Radio uses the Radio ID to send an activation signal that allows the aera 796 to display weather data and/or entertainment programming provided through the GXM 40 antenna.

Refer to the GXM 40 Owner's Manual for more information on activating SiriusXM Satellite Radio.

SIRIUSXM WEATHER INFORMATION

- Radio ID—Eight-digit ID number used for activation.
- Service Level—SiriusXM Weather subscription plan purchased.
- Weather Products—List of weather features and age of weather data in minutes.

Accessing the Radio ID:

From the **Main Menu**, touch **Weather** > **Menu** > **Information**.



Accessing the SiriusXM Radio ID

SIRIUSXM SATELLITE WEATHER PRODUCTS

NEXRAD

NEXRAD (NEXT-generation RADar), is a network of 158 high-resolution Doppler radar systems that are operated by the National Weather Service (NWS). NEXRAD data provides centralized meteorological information for the continental United States and selected overseas locations. The maximum range of a single NEXRAD radar site is 250 nm. In addition to a wide array of services, the NEXRAD network provides important information about severe weather and air traffic safety.

NEXRAD data is not real-time. The lapsed time between collection, processing, and dissemination of NEXRAD images can be significant and may not reflect the current radar synopsis. Due to the inherent delays and the relative age of the data, it should be used for long-range planning purposes only. Never use NEXRAD data or any radar data to penetrate hazardous weather. Rather, use it in an early-warning capacity of pre-departure and enroute evaluation.

Composite data from all the NEXRAD radar sites in the United States is shown. This data is composed of the maximum reflectivity from the individual radar sweeps. The display of the information is color-coded to indicate the weather severity level.

The display of radar coverage is always active when NEXRAD is selected. Areas where NEXRAD radar coverage is not currently available or is not being collected are indicated in grayish-purple. Radar capability exists in these areas, but it is not active or is off-line.

NEXRAD ABNORMALITIES

There are possible abnormalities regarding displayed NEXRAD images. Some, but not all, of those include:

- Ground clutter
- Strokes and spurious radar data
- Sun strokes, when the radar antenna points directly at the sun
- Military aircraft deploy metallic dust (chaff) which can cause alterations in radar scans
- Interference from buildings or mountains, which may cause shadows

NEXRAD LIMITATIONS

Certain limitations exist regarding the NEXRAD radar displays. Some, but not all, are listed for the user's awareness:

- NEXRAD base reflectivity does not provide sufficient information to determine cloud layers or precipitation characteristics (hail vs. rain). For example, it is not possible to distinguish between wet snow, wet hail, and rain.

- NEXRAD base reflectivity is sampled at the minimum antenna elevation angle. An individual NEXRAD site cannot depict high altitude storms at close ranges, and has no information about storms directly over the site.
- Radar coverage only extends to 55°N.
- Any precipitation displayed between 52°N and 55°N is unknown.

NEXRAD INTENSITY

Colors are used to identify the different NEXRAD echo intensities (reflectivity) measured in dBZ (decibels of Z). “Reflectivity” (designated by the letter Z) is the amount of transmitted power returned to the radar receiver. The dBZ values increase as returned signal strength increases. Precipitation intensity is displayed using colors corresponding to the dBZ values.



RADAR Legend

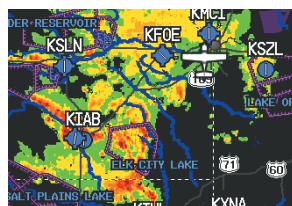

NEXRAD Data

SATELLITE MOSAIC

Satellite Mosaic displays infrared composite images of cloud cover taken by geostationary weather satellites. The Satellite Mosaic provides up to seven levels of cloud cover.



RADAR Legend

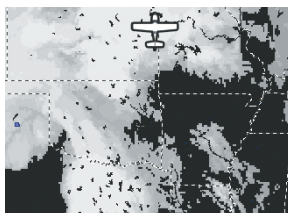

Satellite Mosaic/Cloud Tops Data

ECHO TOPS

Echo Tops are derived from NEXRAD radar and indicate the highest altitude at which precipitation is falling. Echo Tops at or above the altitude you select are displayed, in 5,000 foot increments up to 70,000 ft. Echo Tops can be helpful in determining the severity of thunderstorms.

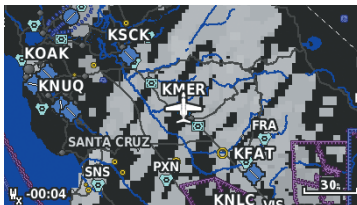

Echo Tops Data



Echo Tops Altitudes

WINDS ALOFT

Winds Aloft data shows the forecasted wind speed and direction at the surface and at selected altitudes. Altitudes can be displayed in 3,000-foot increments up to 42,000 feet MSL.

Winds Aloft are displayed using wind barbs or a wind streamline depending on the selected range. The wind barbs indicate wind speed and direction. The wind streamline indicates wind direction with arrows.

The wind barbs always point in the direction that the wind is coming from. The wind speed is depicted using flags at the end of the wind barb. A short wind flag is 5 knots, a long wind flag is 10 knots, and a triangle flag is 50 knots.

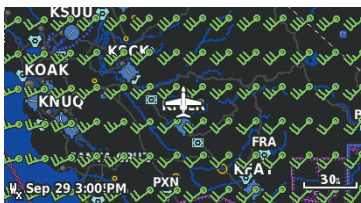

Winds Aloft Data



Winds Aloft Altitudes

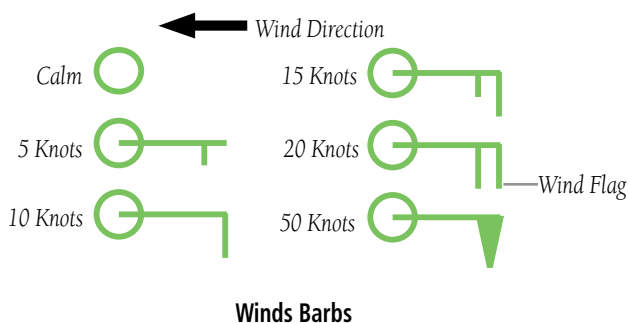

SIRIUSXM LIGHTNING

Lightning data shows the approximate location of cloud-to-ground lightning strikes. A strike icon represents a strike that has occurred within a two-kilometer region and within the last seven minutes. The exact location of the lightning strike is not displayed.

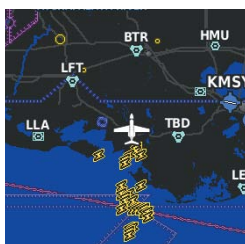

Lightning Data

STORM CELLS

The Storm Cells feature displays storms as well as the storm’s projected path in the immediate future.

The direction of the storm is displayed by an arrow. The map range at which the arrow is displayed depends on the storm cell’s speed. The tip of the arrow indicates where the storm should be in 15 minutes. Critical information about the storm cell (tops and intensity) can be viewed by selecting the storm cell with the map pointer. Touching the Map Feature Button will display additional information.

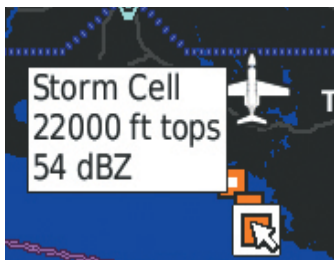

Storm Cell Data (Map)

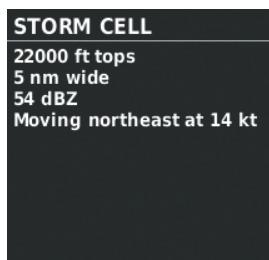

Additional Storm Cell Information

METARS AND TAFS



NOTE: METAR information is only displayed within the installed aviation database service area.

METAR (METeorological Aerodrome Report) is an international code used for reporting weather observations. METARs are updated hourly or as needed. METARs typically contain information about the temperature, dewpoint, wind, precipitation, cloud cover, cloud heights, visibility, and barometric pressure. They can also contain information on precipitation amounts, lightning, and other critical data. If METAR data is available for an airport, a color-coded flag is shown next to the airport.

TAF (Terminal Area Forecast) is the standard format for 24-hour weather forecasts. TAFs may contain some of the same code as METAR data. It typically forecasts significant weather changes, temporary changes, probable changes, and expected changes in weather conditions.

An abbreviated version can be viewed by selecting the METAR flag with the map pointer. Touching the Map Feature Button will display additional information. METAR and TAF data can be displayed as raw or decoded text.

METAR Selected with Map Pointer

Map Feature Button







METAR Data (Map)



Additional METAR Data

The METAR flag color is determined by the information in the METAR text.

-  VFR (ceiling greater than 3000 feet AGL and visibility greater than 5 miles)
-  Marginal VFR (ceiling 1000-3000 feet AGL and/or visibility 3-5 miles)
-  IFR (ceiling 500 to below 1000 feet AGL and/or visibility 1 mile to less than 3 miles)
-  Low IFR (ceiling below 500 feet AGL or visibility less than 1 mile)
-  METAR text does not contain adequate information to determine flight conditions

AIRMETS

An AIRMET (AIRmen’s METeorological Information) can be especially helpful for pilots of light aircraft that have limited flight capability or instrumentation. An AIRMET must affect or be forecast to affect an area of at least 3,000 square miles at any one time. AIRMETS are routinely issued for six-hour periods and are amended as necessary due to changing weather conditions. AIRMETS are displayed as colored, dashed lines.

AIRMET Selected

Additional AIRMET Data

SIGMETS

A SIGMET (SIGnificant METeorological Information) advises of weather that is potentially hazardous to all aircraft. In the contiguous United States, the following items are covered: severe icing, severe or extreme turbulence, volcanic ash, dust storms, and sandstorms that lower visibility to less than three statute miles.

A Convective SIGMET is issued for the following conditions: thunderstorms, isolated severe thunderstorms, embedded thunderstorms, hail at the surface, and tornadoes.

A SIGMET is widespread and must affect or be forecast to affect an area of at least 3,000 square miles. SIGMETs are displayed as a yellow-dashed line.

TEMPORARY FLIGHT RESTRICTIONS (TFRS)

Temporary Flight Restrictions or TFRs temporarily restrict all aircraft from entering the selected airspace unless a waiver has been issued. TFRs are routinely issued for occurrences such as sporting events, dignitary visits, military depots and forest fires. TFRs are represented as an area highlighted by red (active) or yellow (not yet active).



TFR Data Selected



Additional TRF Information

PIREPS

Pilot Weather Reports (PIREPs) provide timely weather information for a particular route of flight. When significant weather conditions are reported or forecast, Air Traffic Control (ATC) facilities are required to solicit PIREPs. A PIREP may contain unforecast adverse weather conditions, such as low in-flight visibility, icing conditions, wind shear, and turbulence. PIREPs are issued as either Routine (UA) (blue) or Urgent (UUA) (yellow).



PIREP Selected

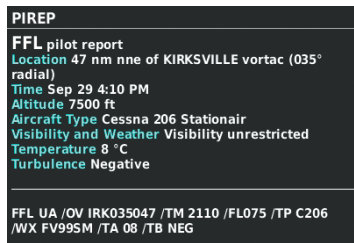

Additional PIREP Data

FREEZING LEVELS

Freezing Level shows contours for the lowest forecast altitude where icing conditions are likely to occur.

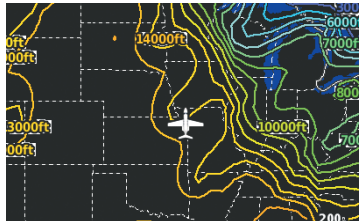

Freezing Level Data

TURBULENCE FORECAST

Turbulence data identifies the potential for erratic movement of high-altitude air mass associated winds. Turbulence is classified as light, moderate, severe, or extreme. Turbulence data is intended to supplement AIRMETS and SIGMETs.

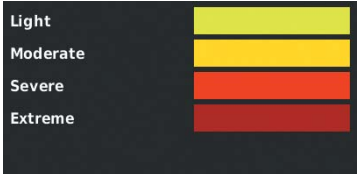

Turbulence Forecast Legend

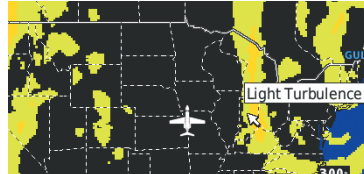

Light Turbulence Selected

ICING FORECAST (CIP & SLD)

Current Icing Product (CIP) data shows a graphical view of the current icing environment. Icing severity is displayed in four categories: light, moderate, severe, and extreme (not specific to aircraft type). The CIP product is not a forecast, but a representation of the current conditions at the time of the analysis.

Supercooled Large Droplet (SLD) icing conditions are characterized by the presence of relatively large, super cooled water droplets indicative of freezing drizzle and freezing rain aloft. SLD threat areas are depicted as magenta dots over the CIP colors.

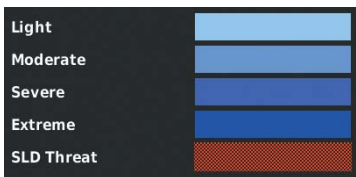

Icing Forecast Legend

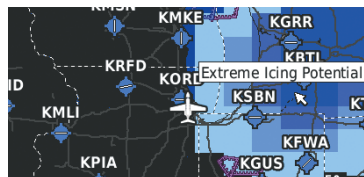

Extreme Icing Selected With Map Pointer

FORECAST

Forecast information is available for current and forecast weather conditions. Forecasts are available for intervals of 12, 24, 36, and 48 hours.

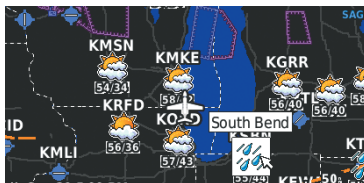

Forecast Data Selected

FORECAST

Forecast for **South Bend, IN**

- 80% chance of Rain today, 55°F
- 70% chance of Rain tonight, 44°F
- Partly Cloudy tomorrow, 60°F / 37°F (10%)
- Clear on Thursday, 65°F / 51°F (10%)

Additional Forecast Information

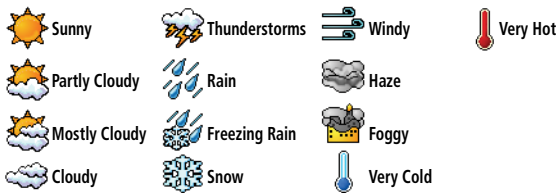

Forecast Legend

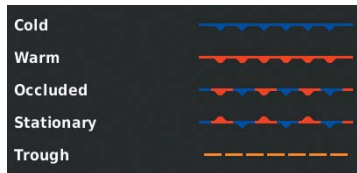

Fronts Legend

SURFACE PRESSURE

This feature displays pressure isobars and pressure centers. The isobars connect points of equal pressure. Pressure readings can help determine weather and wind conditions. High pressure areas are generally associated with fair weather. Low pressure areas are generally associated with clouds and the chance of precipitation. Isobars that are packed closely together show a strong pressure gradient. Strong gradients are associated with areas of stronger winds. Pressure units can be displayed in Millibars (mb) and Inches of Mercury (in).

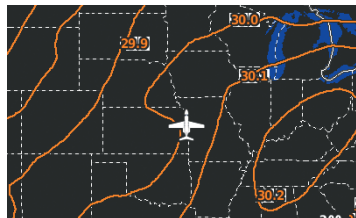

Surface Pressure Data

WATER TEMPERATURE

The surface temperatures of coastal and large inland bodies of water are displayed.

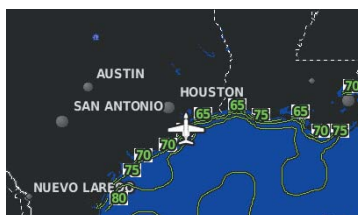

Water Temperature Data

USING SIRIUSXM SATELLITE WEATHER PRODUCTS

SiriusXM Weather Products can be displayed on the Navigation Map and individually on the Weather Maps.

The setup menu for the Navigation Map controls the map range settings above which weather products are decluttered from the display. If a map range larger than the weather product map range setting is selected, the weather product data is removed from the map. For weather products such as Lightning, and Storm Cells, the weather product is displayed when a map range "smaller" than the weather product map range setting is selected (Satellite Mosaic works inversely). The menu also provides a means for enabling/disabling display of 'Airmets', 'Sigmets', 'Weather Data', 'NEXRAD', and/or 'Fronts' on the Navigation Map.

Additional information about the following can be displayed by panning over the display on map:

- Storm Cells
- SIGMETs
- AIRMETs
- METARs
- TFRs

Additional information is also available for the following weather products on the Weather Map (not displayed on the Navigation Map):

- Forecast
- PIREPs

Viewing SiriusXM Weather products on the Navigation Map:

- 1) From the **Main Menu** touch the **Map** Icon.
- 2) Touch the **Menu** Icon.
- 3) Touch the '**Show/Hide...**' menu option.
- 4) Touch the **Weather 'Show/Hide'** Button.

Viewing SiriusXM Weather products on the Weather Map:

- 1) From the **Main Menu** touch the **Weather** Icon.
- 2) Touch the desired second-level Weather Icon.
- 3) If necessary, touch the ◀▶ buttons to scroll through the list of available altitudes, AIRMET types, or forecast times.
- 4) Touch the desired weather product to get abbreviated information about the selected weather product (if available).
- 5) With the desired weather product highlighted, touch the Map Feature Button to get detailed information (if available).

METAR Selected with Map Pointer

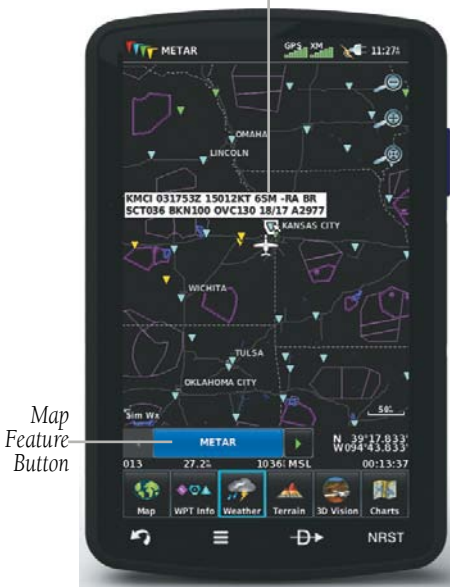

METAR Data (Map)



Additional METAR Data

Setting up and customizing weather data for the Navigation Map:

- 1) From the **Main Menu** touch the **Map** Icon.
- 2) Touch the **Menu** Icon.
- 3) Touch the '**Set Up Map**' menu option.
- 4) Touch the ◀▶ buttons to select the '**Weather**' Category.
- 5) Touch the desired setting to change.
- 6) Touch the ◀▶ buttons (if available) to select the desired settings or touch the **On/Off** Button (if available).



Map Setup (Weather Category)

Restoring default weather data for the Navigation Map:

- 1) From the **Main Menu**, touch **Map** > **Menu** > **Set Up Map**.
- 2) Touch the ◀▶ buttons until the '**Weather**' Category is displayed.
- 3) Touch the **Menu** Icon.
- 4) Touch the '**Restore Weather Defaults**' menu option.

Viewing legends for displayed weather products:

- 1) From the **Main Menu**, touch the **Map** Icon.
Or:
 - a) From the '**Home**' Screen, touch the **Weather** Icon.
 - b) Touch the desired second-level weather icon.
- 2) Press the **Menu** Icon.
- 3) Touch the '**Weather Legend**' menu option.
- 4) If desired, touch the  buttons until the desired legend is displayed.
Or:
Touch the **Back** Icon to return to the map.

Animating SiriusXM weather:

- 1) From the **Main Menu**, touch the **Map** Icon (weather must be enabled).
Or:
 - a) From the **Main Menu**, touch the **Weather** Icon.
 - b) Touch the **NEXRAD** Icon or the **Satellite** Icon.
- 2) Touch the **Menu** Icon.
- 3) Touch the '**Animate Weather**' menu option.

4.2 TERRAIN



WARNING: Do not use Terrain information for primary terrain avoidance. Terrain information is intended only to enhance situational awareness.



NOTE: Terrain depicted in the Profile View is always "ahead" of the aircraft, and will change as ground track changes.

The Terrain function displays altitudes of terrain and obstructions relative to the aircraft position and altitude with reference to a database that may contain inaccuracies. Terrain and obstructions are shown only if they are in the database. Terrain and obstacle information should be used as an aid to situational awareness. They should never be used to navigate or maneuver around terrain.

Note that all obstructions may not be available in the terrain and obstacle database. No terrain and obstacle information is shown without a valid 3-D GPS position.

The aera 795/796 GPS receiver provides the horizontal position and altitude of the aircraft. Aircraft GPS altitude is derived from satellite position. GPS altitude is then converted to a mean sea level (MSL)-based altitude (GPS-MSL altitude) and is used to determine terrain and obstacle proximity. GPS-MSL altitude accuracy is affected by satellite geometry, but is not subject to variations in pressure and temperature that normally affect pressure altitude sensors. GPS-MSL altitude does not require local altimeter settings to determine MSL altitude. It is a widely-used MSL altitude source.

Terrain and obstacle databases are referenced to MSL. Using the GPS position and altitude, the Terrain feature portrays a 2-D picture of the surrounding terrain and obstacles relative to the position and altitude of the aircraft. GPS position and GPS-MSL altitude are used to calculate and predict the aircraft's flight path in relation to the surrounding terrain and obstacles. In this way, the pilot can view predicted dangerous terrain and obstacle conditions.

Alert windows appear to inform the pilot of proximity to the terrain and obstacles, as well as an unsafe descent rate. These alerts depend on user-defined parameters in the Terrain Setup.

TERRAIN INFORMATION











Two views are displayed by the Terrain function: the Map View, and the Profile View. The areas of the terrain shaded red are predicted to be within 100 feet below or above the aircraft. The yellow terrain areas are between the user-defined Caution Elevation and 100 feet below the aircraft. By default, the Caution Elevation is 1,000 feet; therefore, the areas in yellow are between 1,000 feet and 100 feet below the aircraft. The black areas are further than the Caution Elevation. A projected point of impact is marked with an "X" symbol.

OBSTACLE INFORMATION

Obstacles are shown on the Terrain Map View, at or below the map range of 12 nm. Obstacles are also shown on the Navigation Map when the map range is set to 5 nm or below.

Standard aeronautical chart symbols are used for lighted or unlighted obstacles taller than 200 feet Above Ground Level (AGL). Refer to the Obstacle Icons legend below.

When selecting an obstacle with the Map Pointer, each obstacle displays the altitude at the top of the obstacle, or Mean Sea Level (MSL). Each obstacle also lists the actual height of the obstacle, or Above Ground Level (AGL).

Unlighted Obstacle		Lighted Obstacle		Potential Impact Points	Obstacle Location
< 1000' AGL	> 1000' AGL	< 1000' AGL	> 1000' AGL		
					WARNING: Red obstacle is above or within 100' below current aircraft altitude
					CAUTION: Yellow obstacle is between 100' and 1000' below current aircraft altitude

Terrain Obstacle Colors and Symbology

TERRAIN AND OBSTACLE COLOR CODE



Red—terrain or obstacle is above or within 100 feet below the aircraft.

Yellow—terrain or obstacle is between the user-defined Caution Elevation and 100 feet below the aircraft.

Enabling/Disabling Terrain Shading on the Navigation Map:

- 1) From the **Main Menu** touch the **Map** Icon.
- 2) Touch the **Menu** Icon.
 - a) Touch the '**Show/Hide...**' menu option.
 - b) Touch the **Terrain 'Show/Hide'** Button to toggle the terrain overlay on/off.

Or:

- a) Touch the **'Set Up Map'** menu option.
- b) Touch the   buttons until the **'Map'** Category is displayed.
- c) Touch the **Terrain Shading** Field.
- d) Touch the **On/Off** Button.

TERRAIN VIEWS

Two terrain views can be displayed: 'Map with Profile' or 'Map Only'.

Changing the terrain view:

- 1) From the **Main Menu** touch the **Terrain** Icon.
- 2) Touch the **Menu** Icon.
- 3) Touch the **'Select Page Layout'** menu option. An option menu is displayed.
- 4) Touch the desired menu option (**'Map with Profile'** or **'Map Only'**).



Terrain Map

TERRAIN ALERTS & SETUP

Enabling/Disabling terrain alerts:

- 1) From the **Main Menu** touch the **Terrain** Icon.
- 2) Touch the **Menu** Icon.
- 3) Touch the '**Enable Alerts**' or '**Disable Alerts**' menu option.

Use the Terrain Setup Menu to set levels for terrain alerts as well as obstacles in or near your flight path.

- **Caution Elevation**—The aera 795/796 will provide an alert if the terrain or obstacle is within the default Caution Elevation or user-defined Caution Elevation.
- **Look Ahead Time**—Determines the maximum time when an alert annunciation occurs. For example, if 120 seconds is selected, the aera 795/796 provides an alert up to 120 seconds before you reach the terrain or obstacle.
- **Alert Sensitivity**—The three Alert Sensitivity settings (Terrain, Obstacle, and Descent Rate) determine what level of alerts are annunciated. The aera 795/796 defaults to 'High' sensitivity, which annunciates all red and yellow alerts at the time set in Look Ahead Time. 'Medium' sensitivity annunciates all of the red and the highest priority of yellow alerts. 'Low' only annunciates red alerts. 'Off' disables the alert.



Setting the Caution Elevation:

- 1) From the **Main Menu** touch the **Terrain** Icon.
- 2) Touch the **Menu** Icon.
- 3) Touch the '**Set Up Terrain**' menu option.
- 4) Touch the 'Caution Elevation' Datafield Button and select the desired caution elevation from the list ('**500ft Below**', '**750ft Below**', and '**1000ft Below**').

Setting the Look Ahead Time:

- 1) From the **Main Menu** touch the **Terrain** Icon.
- 2) Touch the **Menu** Icon.
- 3) Touch the '**Set Up Terrain**' menu option.
- 4) Touch the 'Look Ahead Time' Datafield Button and select the desired Look Ahead Time from the list ('**60 Seconds**', '**90 Seconds**', and '**120 Seconds**').

Adjusting the Alert Sensitivity:

- 1) From the **Main Menu** touch the **Terrain** Icon.
- 2) Touch the **Menu** Icon.
- 3) Touch the '**Set Up Terrain**' menu option.
- 4) Touch the   buttons to cycle through the list of available sensitivity settings (**Off**, **Low**, **Medium**, or **High**) for Terrain Alerts, Obstacle Alerts, and Descent Rate.

Terrain, Obstacle, and Descent Rate Alerts are issued when flight conditions meet parameters that are set within the software algorithms. Terrain alerts typically employ a CAUTION or a WARNING alert severity level, or both. When an alert is issued, visual annunciations are displayed and aural alerts are simultaneously issued. When the aircraft descends through 500 feet above the destination airport an audible “Five Hundred” altitude reminder occurs.

The Terrain Alert Annunciation is shown to the lower left corner of the screen. If the Terrain Map is not displayed, a pop-up alert appears. The Range Rings on the pop-up alert are spaced every whole mile/kilometer/nautical mile. Touch the Terrain Alert Annunciation to acknowledge the pop-up and/or aural alert.

AURAL ALERTS

- “Five Hundred”—when the aircraft descends through 500 feet above the destination airport.

The following aural terrain alerts are issued when flight conditions meet parameters that are set within the software algorithms, and are dependant on the sensitivity level set in the Terrain Setup Menu.

Alert	Terrain	Obstacle	Descent Rate
Caution	“caution, terrain” “caution, terrain ahead”	“caution, obstacle” “caution, obstacle ahead”	“caution, sink rate”
Warning	“terrain ahead! pull up!” “terrain! terrain! pull up! pull up!”	“obstacle ahead! pull up!” “obstacle! obstacle! pull up! pull up!”	“sink rate, pull up!” “pull up!”

Aural Alerts Summary

Adjusting terrain alert audio:

- 1) From the **Main Menu**, touch **Tools > Setup > Sound**.
- 2) Touch the **Terrain Audio On/Off** Button to toggle the terrain audio on/off, or touch the **Alerts**  Icon to mute both Terrain and TIS alerts.

Or:

Touch the **Alerts**  buttons to select an alert volume (0-10).

4.3 TRAFFIC INFORMATION SERVICE (TIS)





NOTE: Refer to Appendix F for general information regarding TIS. Refer to Appendix D for configuration information.

The aera 795/796 supports TIS input from a Garmin Mode S transponder, such as the GTX 330.

TIS SYMBOLOGY

TIS traffic is shown according to TCAS symbology, graphically shown on the Navigation Map, and in the Traffic Warning Window. A Traffic Advisory (TA) symbol appears as a solid yellow circle. All other traffic is shown as a hollow white diamond. Altitude deviation from own aircraft altitude is shown above the target symbol if traffic is above own aircraft altitude, and below the symbol if they are below own aircraft altitude. Altitude trend is shown as an up arrow (>+500 ft/min), down arrow (<-500 ft/min), or no symbol if less than 500 ft/min rate in either direction.

TIS Symbol	Description
	Traffic Advisory (TA)
	Other Traffic

TIS Traffic Symbols

TIS ALERTS

A TIS audio alert is generated whenever the number of Traffic Advisories on the aera 795/796 screen increases from one scan to the next. Limiting Traffic Advisories only reduces the “nuisance” alerting due to proximate aircraft. For example, when the first Traffic Advisories appear on the TIS display, the user is alerted audibly. So long as a single aircraft remains on the TIS display, no further audio alert is generated. If a second (or more) aircraft appears on the screen, a new audio alert is sounded.

If the number of Traffic Advisories on the TIS display decreases and then increases, a new audio alert is sounded. The TIS audio alert is also generated whenever TIS service becomes available. The following TIS audio alerts are available:

- “Traffic” —TIS traffic alert received.
- “Traffic Not Available” —TIS service is not available or out of range.

Adjusting TIS audio:

- 1) From the **Main Menu**, touch **Tools** > **Setup** > **Sound**.
- 2) Touch the **TIS Audio On/Off** Button to toggle the terrain audio on/off, or touch the **Alerts**  icon to mute both TIS and Terrain alerts.

Or:

Touch the **Alerts**  buttons to select an alert volume (0-10).

TRAFFIC WARNING WINDOW

When a traffic threat is imminent, the Traffic Warning Window is shown. The Traffic Warning Window shows a small pop-up thumbnail map in the lower left corner. The Range Rings on the pop-up alert are spaced every whole mile/kilometer/nautical mile. Touch the Traffic Warning Window to acknowledge and remove it.



NOTE: The Traffic Warning Window is disabled when the aircraft ground speed is less than 30 knots or when on the approach leg of a route.

TRAFFIC GROUND TRACK

Traffic ground track is indicated on the aera 795/796 screen by a “target track vector”, a short line shown in 45-degree increments, extending in the direction of target movement.

DISPLAYING TRAFFIC DATA

TIS traffic can be displayed on the Navigation Map.

Adjusting TIS settings on the navigation map:

- 1) From the **Main Menu**, touch **Map > Menu > Set Up Map**.
- 2) Touch the **◀▶** buttons to select the **Map** Category.
- 3) Touch **TIS Traffic**.
- 4) Touch the **◀▶** buttons to select the desired settings ('Off', 'Auto', or range settings).

Displaying TIS information using the map pointer:

With traffic displayed on the Navigation Map, touch the desired TIS symbol on the map. The traffic range and altitude separation is displayed.



TIS (Navigation Map)

Blank Page

SECTION 5 ADDITIONAL FEATURES



NOTE: With the availability of SafeTaxi and FliteCharts in electronic form, it is still advisable to carry another source of charts on board the aircraft.

The following additional features are included with the aera 795 and/or 796 depending on the unit.

Additional Features	Unit			
	aera 796	aera 795 Americas	aera 795 Atlantic	aera 795 Pacific
3D Vision	+	+	+	+
Airport Directory	+	+	+	+
Chart View	+	+	+	+
FliteCharts®	+	+		
VFR/IFR Chart Viewing	+	+		
SafeTaxi®	+	+		
SiriusXM®	+			
Electronic Checklists	+	+	+	+

Additional Features

5.1 3D VISION

3D Vision provides a three-dimensional view of terrain features as seen from outside the aircraft. 3D Vision imagery shows the relevant features in relation to the aircraft.



WARNING: Use appropriate systems for navigation, and for terrain, obstacle, and traffic avoidance. 3D Vision does not provide either the accuracy or reliability upon which to base decisions and/or plan maneuvers to avoid terrain, obstacles, or traffic.

3D Vision is a visual enhancement to the aera 795/796. 3D Vision depicts the topography as seen from outside the aircraft. The depicted imagery is derived from the aircraft's three-dimensional position, and databases of terrain, obstacles, and other relevant features. Loss of the GPS signal, will cause 3D Vision to be disabled until it is restored.

The 3D Vision terrain display shows land contours (colors are consistent with those of the topographical map display), large water features, towers, and other obstacles over 200' AGL that are included in the obstacle database (if present). Cultural features on the ground such as roads, highways, railroad tracks, cities, and state boundaries are not displayed even if those features are found on the Navigation Map. The terrain display also includes a north-south east-west grid with lines oriented with true north.

Terrain is integrated within 3D Vision to provide visual and auditory alerts to indicate the presence of terrain and obstacle threats relevant to the projected flight path. Terrain alerts are displayed in red and yellow shading.

3D Vision does not provide the accuracy or fidelity on which to base decisions and plan maneuvers to avoid terrain or obstacles. Navigation should not be predicated upon the use of the terrain or obstacle data displayed by 3D Vision.

Touch and drag the three-dimensional view to change the perspective.

3D VISION OPERATION

3D Vision is accessed from the **Main Menu**.

Viewing 3D Vision:

From the **Main Menu**, touch **3D Vision**

Show/Hide 3D Vision Tapes:

From the **Main Menu**, touch **3D Vision > Menu > Show/Hide Tapes**.

Selecting 3D Vision Page Layout:

From the **Main Menu**, touch **3D Vision > Menu > Select Page Layout**

Setting the 3D Vision Bug Indicator:

From the **Main Menu**, touch **3D Vision > Menu > Set Bug Indicator**

Changing the information shown in the data fields:

- 1) With the Data Fields shown on the Navigation Map and the '3D Vision with Map' layout selected, from the **Main Menu**, touch **3D Vision > Menu > Change Data Fields**.
- 2) Touch the desired Data Field to change. A list of available Data Fields is displayed.
- 3) Touch the desired Data Field Option.
- 4) Touch **OK**. The changes made will be mirrored on the Navigation Map.

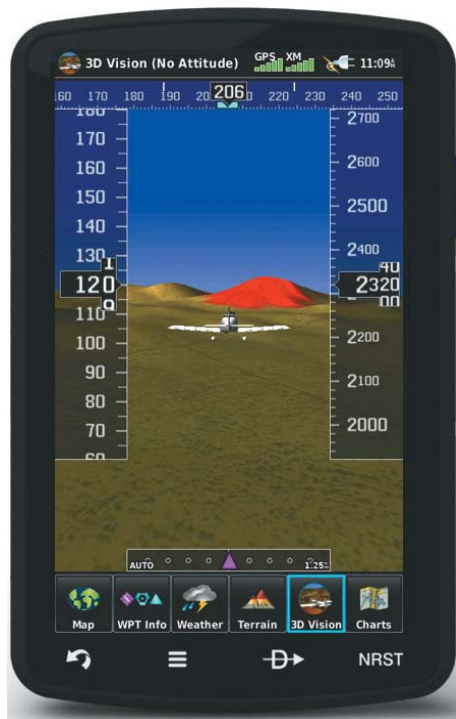







3D Vision

5.2 AIRPORT DIRECTORY DATA

The Airport Directory contains airport statistics such as pattern altitudes, noise abatement information, FBO phone numbers, hours of operation, local attractions, ground transportation, lodging, and services.

Viewing Airport Directory information:

- 1) From the **Main Menu**, touch **WPT Info** > **AOPA** Tab.
 - 2) Touch the Waypoint Identifier Button.
 - 3) Enter the desired waypoint:
 - a) Touch the   buttons to display the desired search option on the 'Search' Button ('**Search by Identifier**', '**Search by Facility Name**', '**Search by City**', '**Search by Address**' (only available with the optional City Navigator data), or '**Search by Crossroads**' (only available with the optional City Navigator data).
 - b) Touch the 'Search' Button (between the  .
 - c) Enter the desired data using the keypad. If duplicate entries are displayed, touch the desired duplicate from the list.
 - d) Touch **OK**.
- Or:**
- a) Touch the   buttons to cycle through the waypoint categories ('**Flight Plan Waypoints**', '**Nearest Airports**', or '**Recent Waypoints**').
 - b) Touch the desired waypoint from the list.
- Or:**
- 1) From the Navigation Map, Weather map, Terrain Map, or VFR/IFR Charts, highlight an airport using the Map Pointer.
 - 2) Touch the Map Feature Button.
 - 3) Touch the **AOPA** Tab (if necessary).

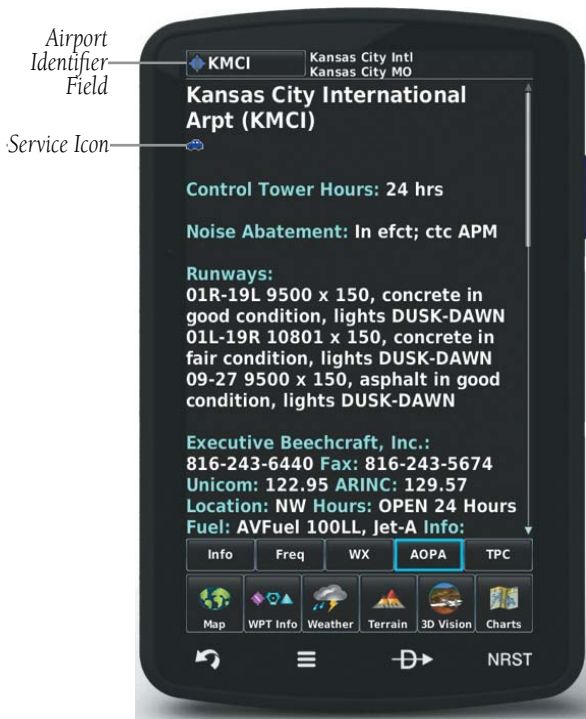

Airport Directory Data

Icon	Description
	Restaurant on Field
	Self Serve Fuel
	Courtesy Car

Airport Directory Service Icons

5.3 CHARTVIEW











NOTE: *Either ChartView or FliteCharts may be used at one time, but not both.*

ChartView resembles the paper version of Jeppesen terminal procedure charts. The aircraft position is displayed on the moving map in the plan view of the approach charts and on airport diagrams.

The ChartView database subscription is available from Jeppesen, Inc. Available data includes:

- Arrivals (STAR)
- Departure Procedures (DP)
- Approaches
- Airport Diagrams
- NOTAMs

Displaying ChartView:

- 1) From the **Main Menu**, touch **WPT Info** > **TERPs** Tab (if necessary).
- 2) Touch the Waypoint Identifier Button (top of page).
- 3) Enter the desired waypoint:
 - a) Touch the   buttons to display the desired search option on the 'Search' Button ('**Search by Identifier**', '**Search by Facility Name**', '**Search by City**', '**Search by Address**' (only available with the optional City Navigator data), or '**Search by Crossroads**' (only available with the optional City Navigator data).
 - b) Touch the 'Search' Button (between the  .
 - c) Enter the desired data using the keypad. If duplicate entries are displayed, touch the desired duplicate from the list.
 - d) Touch **OK**.
- Or:**
 - a) Touch the   buttons to cycle through the waypoint categories ('**Flight Plan Waypoints**', '**Nearest Airports**', or '**Recent Waypoints**').
 - b) Touch the desired waypoint from the list.
- 4) Touch the   buttons to cycle through the available Charts or touch the Chart Field and touch the desired Chart from the vertical list.

Or:

- 1) From the map, highlight an airport using the Map Pointer.
- 2) Touch the Map Feature Button.
- 3) Touch the **TERPs** Tab (if necessary).
- 4) Touch the  buttons to cycle through the available Charts or touch the Chart Field and touch the desired Chart from the vertical list.

Displaying ChartView in Full Screen Mode:

- 1) From the **Main Menu**, touch **WPT Info** > **TERPs** (if necessary).
- 2) With the desired chart displayed touch **TERPs** again.
- 3) Touch the  icon to exit Full Screen Mode.

When a terminal procedure chart is not available for the requested airport or there is an error rendering the data, the banner "CHART NOT AVAILABLE" appears on the screen. The "CHART NOT AVAILABLE" banner does not refer to the ChartView subscription, but rather the availability of a particular airport chart selection or procedure for a selected airport.

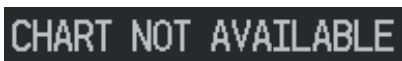
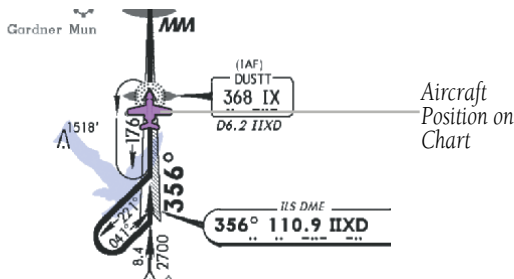

Chart Not Available Banner

AIRCRAFT SYMBOL

The aircraft symbol is shown in magenta on the chart only if the chart is to scale and the aircraft position is within the boundaries of the chart. The aircraft symbol is not displayed when the Aircraft Symbol Not Shown Icon (X over the aircraft symbol) appears in the lower right corner. The Aircraft Symbol Not Shown Icon may appear at certain times (e.g., a loss of GPS), even if the chart is displayed to scale.



Aircraft Symbol Displayed on Chart (Waypoint Page)
Single Display



CHART RANGE

Changing the ChartView range:

Use the  (out) or  (in) icons to zoom 'out' (increasing), or zoom 'in' (decreasing).

Or:

Pinch fingers together (zoom out), or pull fingers apart (zoom in).

JEPPESEN DATABASE-PUBLISHED NOTAMS



NOTE: Only NOTAMs for the selected airport are shown (when available). There may be other NOTAMs available pertaining to the flight that may not be displayed. Contact Jeppesen for more information regarding Jeppesen database-published NOTAMs.

Recent NOTAMs applicable to the current ChartView cycle are included in the ChartView database. If NOTAMs are available for the selected airport, a 'Chart NOTAMs' option will be displayed at the bottom of the drop-down menu of available charts. Select the 'Chart NOTAMs' option from the chart menu to display the applicable NOTAM information.

5.4 FLITECHARTS





NOTE: Either ChartView or FliteCharts may be used at one time, but not both.



FliteCharts resemble the paper version of National Aeronautical Charting Office (NACO) terminal procedures charts. The charts are displayed with high-resolution and in color for applicable charts. FliteCharts database subscription is available from Garmin. Available data includes:

- Arrivals (STAR)
- Departure Procedures (DP)
- Approaches
- Airport Diagrams
- Takeoff Minimums
- Alternate Minimums

Displaying FliteCharts:

- 1) From the **Main Menu**, touch **WPT Info** > **TERPs** Tab (if necessary).
 - 2) Touch the Waypoint Identifier Button (top of page).
 - 3) Enter the desired waypoint:
 - a) Touch the  buttons to display the desired search option on the 'Search' Button ('**Search by Identifier**', '**Search by Facility Name**', '**Search by City**', '**Search by Address**' (only available with the optional City Navigator data), or '**Search by Crossroads**' (only available with the optional City Navigator data).
 - b) Touch the 'Search' Button (between the .
 - c) Enter the desired data using the keypad. If duplicate entries are displayed, touch the desired duplicate from the list.
 - d) Touch **OK**.

Or:

 - a) Touch the  buttons to cycle through the waypoint categories ('**Flight Plan Waypoints**', '**Nearest Airports**', or '**Recent Waypoints**').
 - b) Touch the desired waypoint from the list.
 - 4) Touch the  buttons to cycle through the available FliteCharts or touch the Chart Field and touch the desired FliteChart from the vertical list.
- Or:**

- 1) From the map, highlight an airport using the Map Pointer.
- 2) Touch the Map Feature Button.
- 3) Touch the **TERPs** Tab (if necessary).
- 4) Touch the  buttons to cycle through the available FliteCharts or touch the Chart Field and touch the desired FliteChart from the vertical list.

Displaying FliteCharts in Full Screen Mode:

- 1) From the **Main Menu**, touch **WPT Info** > **TERPs** (if necessary).
- 2) With the desired chart displayed touch **TERPs** again.
- 3) Touch the  icon to exit Full Screen Mode.

When a terminal procedure chart is not available for the requested airport or there is an error rendering the data, the banner "CHART NOT AVAILABLE" appears on the screen. The "CHART NOT AVAILABLE" banner does not refer to the FliteCharts subscription, but rather the availability of a particular airport chart selection or procedure for a selected airport.



AIRCRAFT SYMBOL

The aircraft symbol is shown in magenta on the chart only if the chart is to scale and the aircraft position is within the boundaries of the chart. The aircraft symbol is not displayed when the Aircraft Symbol Not Shown Icon appears. The Aircraft Symbol Not Shown Icon may appear at certain times, even if the chart is displayed to scale.

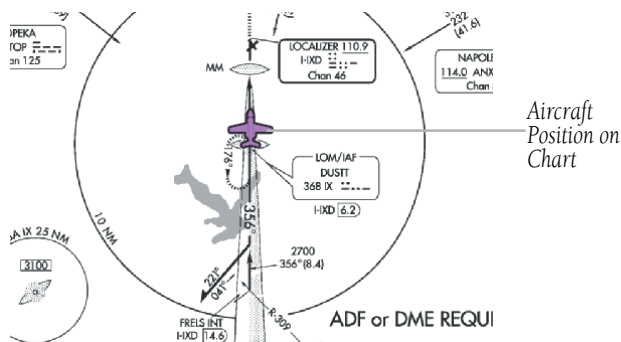

**Aircraft Symbol Displayed on Chart (Waypoint Page)
Single Display**

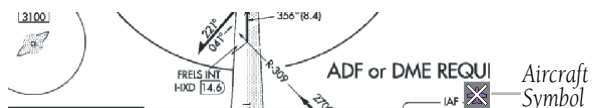

**Aircraft Symbol Not Shown Icon (Waypoint Page)
Single Display**

FLITECHART RANGE

Changing the FliteChart range:

Use the (out) or (in) icons to zoom 'out' (increasing), or zoom 'in' (decreasing).

Or:

Pinch fingers together (zoom out), or pull fingers apart (zoom in).

FLITECHARTS CYCLE NUMBER AND EXPIRATION DATE

FliteCharts data is revised every 28 days. On Power-up the aera 795/796 indicates any of five different possible criteria for chart availability. These indications are whether the databases are not configured, not available, current, out of date, or disabled.

5.5 VFR/IFR CHART VIEWING



NOTE: VFR, IFR, and TPC Charts can be obtained by visiting the 'flyGarmin' website (www.fly.garmin.com).

Accessing VFR/IFR Charts:

- 1) Obtain the desired charts from the 'flyGarmin' website.
- 2) From the **Main Menu**, touch **Charts**.
- 3) Touch **Menu**. The 'Chart Type' Menu is displayed.
- 4) Touch the desired chart type ('VFR', 'IFR Low', 'IFR High', or 'TERPs').

Activating the chart pointer on a VFR/IFR chart:

While viewing a Chart, touch anywhere on the Chart to activate the map pointer.

Panning VFR/IFR Charts:

While viewing a Chart, touch anywhere on the chart and drag.

Reviewing information for a VFR/IFR chart feature:

- 1) While viewing a chart, touch anywhere on the chart to activate the chart pointer. When the Chart Pointer is over a chart feature an information box appears on the map, and the chart feature is displayed on the Chart Feature Button (the button located between the ◀▶ buttons). If multiple features are present at the Chart Pointer position, green arrows will appear on the Chart Feature Button.
- 2) Touch the Chart Feature Button to review information for the Chart Feature.
- 3) If desired touch the **Direct-to** ▶ icon to navigate to the chart feature.

5.6 SAFETAXI

SafeTaxi is an enhanced feature that gives greater map detail when viewing airports at close range. When viewing at ranges close enough to show the airport detail, the map reveals taxiways with identifying letters/numbers, runway incursion "Hot Spots", and airport landmarks including ramps, buildings, control towers, and other prominent features. Resolution is greater at lower map ranges. The SafeTaxi features can be seen when panning over the airport on the Navigation Map.

Designated Hot Spots are recognized at airports with many intersecting taxiways and runways, and/or complex ramp areas. Airport Hot Spots are outlined to caution pilots of areas on an airport surface where positional awareness confusion or runway incursions happen most often. Hot Spots are defined by a red shaded area.

During ground operations the aircraft's position is displayed in reference to taxiways, runways, and airport features. When panning over the airport, features such as runway holding lines and taxiways are shown at the cursor.



SafeTaxi Depiction

Enabling/disabling SafeTaxi:

- 1) From the **Main Menu**, touch **Map** > **Menu** > **Set Up Map**.
- 2) Touch the  buttons to display the 'Airport' Category.
- 3) Touch the 'Safetaxi' On/Off Button.

SAFETAXI CYCLE NUMBER AND REVISION

SafeTaxi database is revised every 56 days. SafeTaxi is always available for use after the expiration date. When turning on the aera 795/796, the database initialization indicates whether the databases are current, out of date, or not available. The database initialization shows the SafeTaxi database is current when the SafeTaxi name and expiration date are shown in white. When the SafeTaxi cycle has expired, the SafeTaxi name and expiration date will appear in yellow.

The SafeTaxi Region, Cycle, Effective date, and Expiration date of the database cycle can also be found from the **Main Menu**, by touching the **Tools > Database**.

The SafeTaxi database is provided by Garmin. Refer to Appendix C for instructions on updating the SafeTaxi database.

5.7 SiriusXM® RADIO (aera 796)



NOTE: *SiriusXM Satellite Radio is only available with the aera 796.*



NOTE: *Refer to the Hazard Avoidance Section for information about SiriusXM Weather products.*



NOTE: *You MUST have a GXM 40 smart antenna connected to your aera 796 and a subscription to SiriusXM Radio to use SiriusXM Radio features.*



NOTE: *Audio interference can occur while using some audio panels. Use of a Ground Loop Isolator can eliminate this interference.*

SiriusXM Satellite Radio offers a variety of radio programming over long distances without having to constantly search for new stations. Based on signals from satellites, coverage far exceeds land-based transmissions. SiriusXM Satellite Radio services are subscription-based.

Accessing SiriusXM Radio:

From the **Main Menu**, touch the **SiriusXM** icon.

ACTIVATING SiriusXM SATELLITE RADIO SERVICES

The service is activated by providing SiriusXM Satellite Radio with a coded ID (Radio ID).

SiriusXM Satellite Radio uses the Radio ID to send an activation signal that, when received by the GXM 40, allows it to play entertainment programming.

Refer to the GXM 40 Owner’s Manual for more information on activating SiriusXM Satellite Radio.

Accessing the Radio ID:

From the **Main Menu**, touch **SiriusXM** > **Menu** > **Information**.

Or:

The Radio ID is also displayed on channel ‘0’. Channel ‘0’ is the first channel listed in the ‘**All Channels**’ Category.



Accessing the SiriusXM Radio ID (SiriusXM Information)



Accessing the SiriusXM Radio ID (Channel 0)

USING SiriusXM RADIO

The SiriusXM Radio function provides information and control of the audio entertainment features of the SiriusXM Satellite Radio.



SiriusXM Radio Overview

CATEGORY

The Category Field cycles through a horizontal list of categories such as jazz, rock, or news.

Selecting a category:

- 1) From the **Main Menu** touch the **SiriusXM** Icon.
- 2) Touch the **◀▶** buttons to cycle through the horizontal category list. The list automatically refreshes with the selected category.



Category Navigation

'Favorites' category shortcut:

Touch and hold the **Category** Button to view the 'Favorites' Category.



'Favorites' Category Shortcut

ACTIVE CHANNEL AND CHANNEL LIST

The Channel List shows a list of the available channels for the selected category. The active channel is outlined blue (in the Channel List).

Selecting a channel from the channel list:

- 1) Scroll through the Channel List by touching and dragging the list up/down or touching and dragging the scrollbar up/down.
- 2) Touch the desired channel. The channel is outlined blue to show it is the active channel.

Entering a channel number:

- 1) From the **Main Menu**, touch **SiriusXM** > **Menu** > **Enter Channel**.
- 2) Touch the '+' or '-' Buttons to enter the desired channel and touch the **Tune** Button.

Or:

Touch the 'Channel Number' Button, enter the desired channel using the numeric keypad, and touch **OK**.



Channel Number Entry

USING FAVORITES

Favorites is a customized category of up to 30 of your SiriusXM Radio favorites.

To add a channel to Favorites:

- 1) From the **Main Menu** touch the **SiriusXM** Icon.
- 2) Touch and hold the desired channel. A confirmation window is displayed.
- 3) Touch **Yes**.

Or:

With the desired channel selected, touch the **Menu** Icon and touch the **'Add To Favorites'** Menu Option. A confirmation window is displayed.

- 4) Touch **Yes**. The channel is added to the **'Favorites'** Category.

Selecting Favorites:

- 1) From the **Main Menu** touch the **SiriusXM** Icon.
- 2) Touch the  buttons to cycle through the horizontal category list until the **'Favorites'** Category is displayed.

Or:

Touch and hold the **Category** Button.

- 3) Scroll through the Channel List by touching and dragging the list up/down.
- 4) Touch the desired channel.

To delete channel(s) from Favorites:

- 1) With the Favorites Category selected, touch the **Menu** Key.
- 2) Touch the **'Remove Favorites'** Menu Option.

Or:

Touch the **'Remove All Favorites'** Menu Option and skip to step 5. The **'Remove all favorites?'** Window is displayed.

- 3) Touch the check box next to the channel to be deleted. A red x will appear in the box.



Delete Channel Checkbox

- 4) Touch **Remove**. The **'Remove selected favorites?'** Window is displayed.

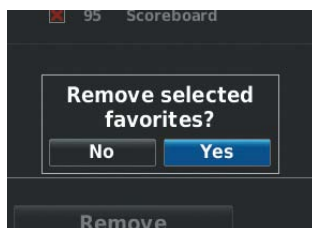

Remove Favorites Window

- 5) Touch **Yes**. The channels are removed from the '**Favorites**' Category.

VOLUME

Volume is broken down into 'Master', 'Alerts', and 'Media'. The 'Master' volume controls all sound. The 'Alerts' volume refers to system alerts (TIS, Terrain), and the 'Media' volume refers to SiriusXM radio volume.



Adjusting the volume:

- 1) From the **Main Menu** touch the **SiriusXM** Icon.
- 2) Touch the **Menu** Icon.
- 3) Touch the '**Volume**' Menu Option.
- 4) Touch the  buttons to increase/decrease the volume.

Sound Setup shortcut:

Touch and hold the **Media**  Icon to quickly access the sound settings.

Muting SiriusXM Audio:

- 1) From the **Main Menu**, touch the **SiriusXM** Icon.
- 2) Touch the **Media**  Icon.
Or:
 - a) Touch the **Menu** Icon.
 - b) Touch the '**Volume**' menu option. 'Sound Setup' is displayed.
 - c) Touch the **Media**  Icon.

5.8 ELECTRONIC CHECKLISTS



NOTE: The information described in this section is not intended to replace the checklist information described in the AFM.



NOTE: Garmin does not create, modify, or update aera 795/796 checklists and thus cannot be responsible for the availability and/or content.



NOTE: Checklists cannot be edited from within the system.

The aera 795/796 is capable of displaying checklists which allow a pilot to quickly find the proper procedure on the ground and during each phase of flight. The aera 795/796 accesses the checklist file (*.ace) located on the SD card. If a checklist file is available on the SD card, the 'Checklists' option can be accessed by touching **Main Menu > Tools > Checklists**.

Garmin ACE (Aircraft Checklist Editor) is available from the garmin website at no cost.

SECTION 6 APPENDICES

APPENDIX A: MESSAGES, ALERTS & DATA FIELD OPTIONS

Overview

GPS Navigation

Flight Planning

Hazard Avoidance

Additional Features

Appendices

Index

MISCELLANEOUS MESSAGE ADVISORIES

Message	Comments
Approaching Target Altitude	Within 200 feet of final VNAV target altitude.
Approaching VNAV Profile	The aircraft is within one minute of reaching the initial VNAV decent point.
Arriving at XXX	The aircraft is nearing the destination.
Battery Low	The battery needs to be recharged.
Can't Unlock Databases	No applicable unlock code for one or more databases was found.
Can't Unlock Maps	No applicable unlock code for one or more maps was found. All MapSource maps are not accessible.
Check XM Antenna	Internal problem with the GXM antenna. Contact Garmin Product Support.
Database Error	Internal problem with the system. Contact your dealer or Garmin Product Support to have the unit repaired.
Fuel Tank	A reminder for switching fuel tanks. The reminder message repeats at the specified interval after the beginning of each trip.
GPS antenna shorted to ground	The GPS antenna connection detects the GPS antenna RF connector is shorted to ground.
Lost Satellite Reception	The system is unable to receive satellite signals.
Memory Full	System memory is full, no further data can be saved.
Near Proximity Point	You have reached the distance set for a proximity waypoint.

MISCELLANEOUS MESSAGE ADVISORIES (CONT.)

Message	Comments
Next DTK XXX	The aircraft is nearing a turn in a route.
Proximity Memory Full	No additional proximity waypoints can be saved.
Proximity Radius Overlaps	The radius of two proximity waypoints overlap.
Route Already Exists	A route name that already exists has been entered.
Route Memory Full	No additional routes can be saved.
Route Truncated	Uploaded route from another device has more than 300 waypoints.
Route Waypoint Memory Full	No additional route waypoints can be saved.
Steep Turn Ahead	Approaching a turn that requires a bank angle in excess of 25 degrees to stay on course.
Track Already Exists	A saved track with the same name already exists.
Track Log Full	The track log is full and track recording was turned off. To record more track points, you need to clear the track log and turn track recording on.
Track Memory Full	No more track data can be stored. Delete the old track data to store the new data.
Track Truncated	A complete uploaded track will not fit in memory. The oldest track log points have been deleted.
VNAV Cancelled	VNAV function has been cancelled due to a change in the active route.
Waypoint Already Exists	A waypoint with the same name already exists.
Waypoint Memory Full	The unit has stored the maximum number of waypoints.

AIRSPACE MESSAGES

Message	Comments
Inside Airspace	Inside the boundaries of the airspace.
Airspace Near and Ahead	Within two nautical miles of an airspace and your current course takes you inside the airspace.
Airspace Ahead, Within 10 Minutes	The projected course takes you inside an airspace within the next 10 minutes or less.
Airspace Near, Within 2 nm	Within two nautical miles of an airspace but not projected to enter it.

DATA FIELD & NUMERIC DATA OPTIONS

Data Field/Numeric Data	Definition
Accuracy	The current accuracy of the GPS determined location.
Altitude	The current altitude in geometric height above Mean Sea Level (MSL).
Bearing	The compass direction from the present position to a destination waypoint.
Course to Steer	The recommended direction to steer in order to reduce cross-track error and return to the course line.
Crosstrack Error	The distance the aircraft is off a desired course in either direction, left or right.
Desired Track	The desired course between the active "from" and "to" waypoints.
Distance (Destination)	The distance to the destination waypoint in the Active Flight Plan
Distance (Next)	The distance to the next waypoint in the Active Flight Plan.
En Route Safe Altitude	The recommended minimum altitude within ten miles left or right of the desired course on a active flight plan or direct-to.
Flight Timer	Total time in-flight (HH:MM).

DATA FIELD & NUMERIC DATA OPTIONS (CONT.)

Data Field/Numeric Data	Definition
Fuel Timer	Elapsed time since the Fuel Tank Reminder Alarm was last issued (HH:MM).
Glide Ratio	The estimated distance an aircraft will move forward for any given amount of lost altitude.
Ground Speed	The velocity that the aircraft is traveling relative to a ground position.
Ground Track	The direction of aircraft movement relative to a ground position.
Minimum Safe Altitude	Uses Grid MORAs to determine a safe altitude within ten miles of the aircraft's present position.
Next Waypoint	The next waypoint in the flight plan or direct-to route.
Sunrise	The time at which the sun rises on this day (current location).
Sunset	The time at which the sun sets on this day (current location).
Estimated Time En Route (Destination)	The estimated time it takes to reach the destination waypoint from the present position, based upon current ground speed.
Estimated Time En Route (Next)	The estimated time it takes to reach the next waypoint from the present position, based upon current ground speed.
Estimated Time of Arrival (Destination)	The estimated time at which the aircraft should reach the destination waypoint, based upon current speed and track.
Estimated Time of Arrival (Next)	The estimated time at which the aircraft should reach the next waypoint, based upon current speed and track.
Estimated Time to VNAV	The estimated time it takes to reach the VNAV waypoint from the present position, based upon current ground speed.

DATA FIELD & NUMERIC DATA OPTIONS (CONT.)

Data Field/Numeric Data	Definition
Time (Local)	The current time and date in 12-hour or 24-hour format.
Time (UTC)	The current time and date in Universal (UTC) time.
Vertical Speed	The rate of climb or descent (GPS-derived).
Vertical Speed Required	The vertical speed necessary to descend/climb from a current position and altitude to the previously selected VNAV position and altitude, based upon current groundspeed.
Weather (Altimeter) (aera 796)	The altimeter setting at the nearest METAR reporting station.
Weather (Dew Point) (aera 796)	The dew point at the nearest weather reporting station.
Weather (Rel. Humidity) (aera 796)	The relative humidity at the nearest weather reporting station.
Weather (Temperature) (aera 796)	The temperature at the nearest weather reporting station.
Weather (Wind) (aera 796)	The wind speed and direction at the nearest weather reporting station.

AURAL ALERTS
TRAFFIC

- “Traffic”—TIS traffic alert received.
- “Traffic Not Available”—TIS service is not available or out of range.

TERRAIN

- “Five Hundred”—when the aircraft descends through 500 feet above the destination airport.

The following aural terrain alerts are issued when flight conditions meet parameters that are set within the software algorithms, and are dependant on the sensitivity level set in the Terrain Setup Menu.

Alert Severity	Terrain	Obstacle	Descent Rate
Caution	"caution, terrain" "caution, terrain ahead"	"caution, obstacle" "caution, obstacle ahead"	"caution, sink rate"
Warning	"terrain ahead! pull up!" "terrain! terrain! pull up! pull up!"	"obstacle ahead! pull up!" "obstacle! obstacle! pull up! pull up!"	"sink rate, pull up!" "pull up!"

Aural Alerts

APPENDIX B: ABNORMAL OPERATION

LOSS OF GPS POSITION

When the aera 795/796 loses the GPS signal for any reason, the following will occur:

- A blinking red question mark will appear over the airplane icon on the map.
- The 'Lost Satellite Reception' message will display.
- Any GPS dependent data fields will not be available.

HAZARD DISPLAY WITH LOSS OF GPS POSITION

If the Terrain function does not have at least a 3D fix (i.e. altitude unknown), a Red X will be displayed.

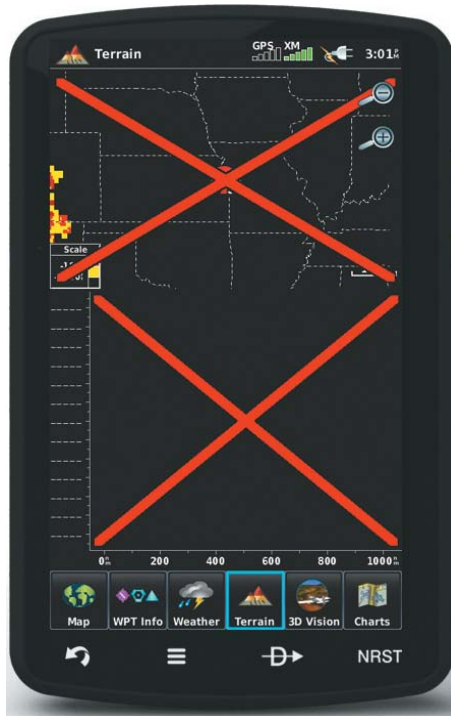

Terrain Red X

APPENDIX C: SD CARDS AND DATABASES

SD CARD USE

The aera 795/796 uses an SD Card for checklist files, Chartview, importing/exporting Flight Plans, and for storing PDF files for use in the aera 795/796 Document Viewer. Garmin recommends using a 4 GB SanDisk or Toshiba SD Card.

INSTALLING AND REMOVING SD CARDS

Install the SD Card in the slot located on the top, right side of the unit. Install or remove the SD Card at any time, whether the unit is on or off.

You can buy pre-programmed SD Cards to use with your aera 795/796.

SD Cards are not waterproof. They should not be exposed to moisture or excessive static charges, and should be stored in the case supplied with the card.

Installing an SD Card:

- 1) Insert the card into the slot on the top, right side of the unit. Be sure the label is facing the back of the unit.
- 2) Firmly push the card into the unit. It is not necessary to force the card. The handle is still exposed when it is properly inserted.
- 3) The unit takes a few seconds to read the card.

If you insert an SD Card and get a card format not recognized message, try removing the card and reinserting it. If the card is still not recognized, contact Garmin Product Support or your Garmin dealer.

Removing an SD Card:

- 1) Push the card into the unit until it stops.
- 2) Release the card. The card should eject for easy removal.
- 3) With the card ejected, pull the card out of the slot.

DATABASES

The following databases are included with the aera 795/796 depending on the unit (Americas, Atlantic, or Pacific). See the Additional Features section for information on Airport Directory, FliteCharts®, and SafeTaxi®. See the Hazard Avoidance section for information on Obstacles and Terrain.

Database	Americas Unit	Atlantic Unit	Pacific Unit
Worldwide Basemap	+	+	+
Airport Directory	+	+	+
Jeppesen® Navigation Database	+	+	+
FliteCharts®	+		
SafeTaxi®	+		
Obstacle	+	+	
Worldwide Terrain	+	+	+
IFR/VFR Charts	+		

Databases

GARMIN DATABASE INFORMATION

The following databases are provided by Garmin:

- Worldwide Basemap
- Worldwide Terrain
- Obstacle
- SafeTaxi
- FliteCharts
- IFR/VFR Charts

WORLDWIDE BASEMAP

The basemap database contains data for the topography and land features, such as rivers, lakes, and towns. It is updated only periodically, with no set schedule. There is no expiration date.

FLITECHARTS

The FliteCharts database contains procedure charts for the United States only. This database is updated on a 28-day cycle.

IFR/VFR CHARTS

The IFR/VFR Chart database contains Sectionals, Hi-Altitude, Low-Altitude, World Aeronautical Charts (WAC), and Terminal Aera Charts (TAC). This database is updated on a 28-day cycle.

SAFETAXI

The SafeTaxi database contains detailed airport diagrams for selected airports. These diagrams aid in following ground control instructions by accurately displaying the aircraft position on the map in relation to taxiways, ramps, runways, terminals, and services. This database is updated on a 56-day cycle.

OBSTACLE

The obstacle database contains data for obstacles, such as towers, that pose a potential hazard to aircraft. Obstacles 200 feet and higher are included in the obstacle database. It is very important to note that not all obstacles are necessarily charted and therefore may not be contained in the obstacle database. This database is updated on a 56-day cycle.

WORLDWIDE TERRAIN



NOTE: The data contained in the terrain and obstacle databases comes from government agencies. Garmin accurately processes and cross-validates the data, but cannot guarantee the accuracy and completeness of the data.

The terrain database is updated periodically and has no expiration date.

GARMIN AVIATION DATABASE UPDATES

The Garmin aviation database updates can be downloaded directly to the unit by visiting the 'flyGarmin' website (fly.garmin.com).

After the databases have been updated, check that the appropriate databases are initialized and displayed on the splash screen during power-up.

OTHER DATABASE INFORMATION

JEPPESSEN NAVIGATION DATABASE

The aera 795/796 includes an internal Jeppesen® database that provides location and facility information for thousands of airports, VORs, NDBs, and more. Updates to the Jeppesen database are available every 28 days online (www.fly.garmin.com). The update program is designed to operate on Windows®-compatible PCs and requires the included USB cable to connect your aera 795/796 to the PC's USB port. The following information is provided from the internal Jeppesen database:

- *Airport—identifier, facility name, city/state/country, latitude/longitude, field elevation, available fuel types, runway designations and layout, runway surface, runway length, runway width, runway lighting, communication frequencies, and published approaches.
- Weather—frequencies associated with an airport (ASOS, ATIS, and AWOS).
- *VORs—identifier, facility name, city/state/country, location (latitude/longitude), frequency, service volume (high, low, terminal), and type (such as VOR-DME, TACAN, and VORTAC).
- *NDBs—identifier, facility name, city/state/country, location (latitude/longitude), and frequency.

- Intersections—identifier, nearest VOR, radial and distance from nearest VOR, location (latitude/longitude), and region/country.
- ARTCC—Air Route Traffic Control Centers.
- Airspace—boundaries (Class B, Class C, Control Zones, SUAs, and MOAs), controlling agency, and vertical boundaries.
- FSS—Flight Service Stations.

* Symbology used for NDBs, VORs, and airports is consistent with those used on a sectional chart.



NOTE: After performing a Jeppesen database update, verify all flight plan (routes) are current. If there is an obsolete Jeppesen aviation point in a saved route, the route is locked and unusable. A new route with current Jeppesen database points will need to be created.

CHARTVIEW

ChartView database is revised every 14 days. Charts are still viewable during a period that extends from the cycle expiration date to the disables date. ChartView is disabled 70 days after the expiration date and is no longer available for viewing.

ChartView data is downloaded from Jeppesen® onto an SD card.

APPENDIX D: INSTALLATION AND INTERFACING

MOUNTING THE aera 795/796 IN THE AIRCRAFT

The aera 795/796 is designed to fit the majority of conventional aircraft yokes and center column controls.

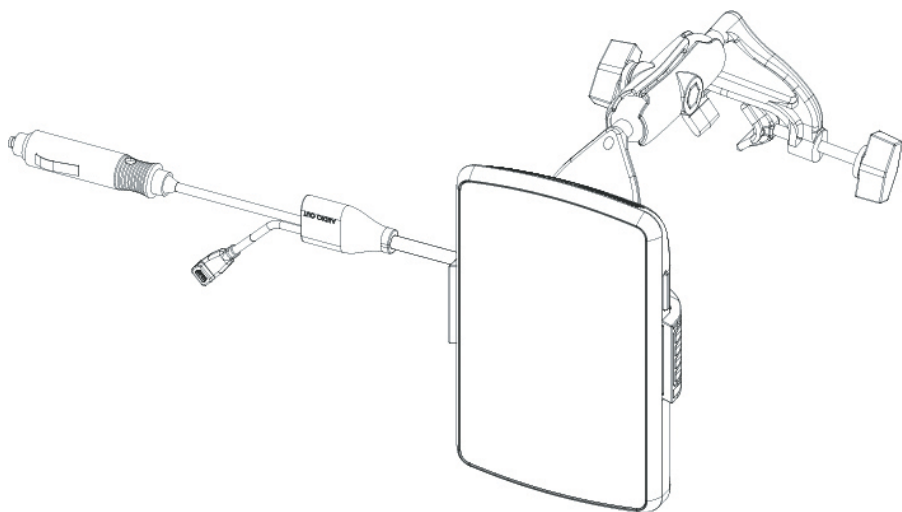

WARNING: It is the sole responsibility of the owner/operator of the aera 795/796 to place this mount and secure the unit so that it will not interfere with the aircraft's operating controls and safety devices, or cause damage or personal injury in the event of an accident or turbulence. Do not mount the aera 795/796 where the pilot or passengers are likely to impact it in an accident, collision, or turbulence. The mounting hardware provided by Garmin is not warranted against turbulence, collision damage, or related consequences.



NOTE: After installation, verify flight controls are free and clear per the flight manual of the applicable aircraft and that the aera 795/796 yoke mount and wiring do not cause any interference with the flight controls.



NOTE: Readjust the position of the aera 795/796 to provide the best view of the display screen as lighting conditions change.

Attaching the yoke mount assembly to the aera cradle:

Join the yoke mount assembly to the aera cradle using the provided screws (4 ea), nuts (4 ea), and washers (8 ea) as shown in the two following drawings. The optional rectangular plate (013-00277-07) is included with the yoke mount.

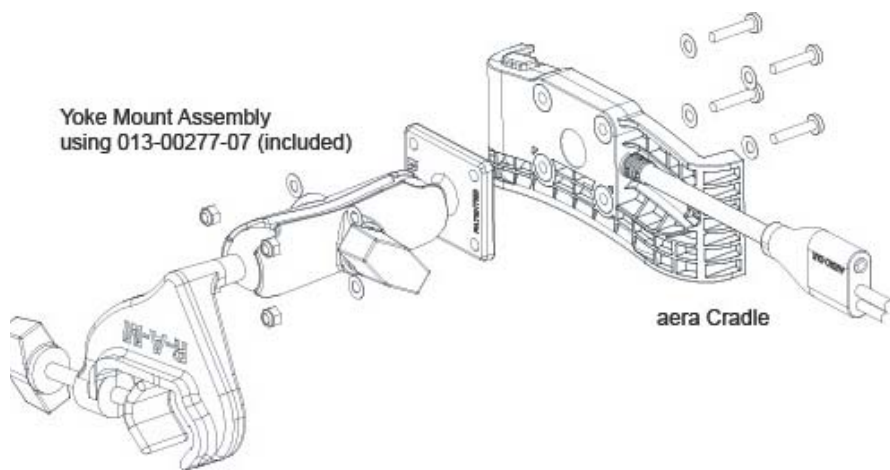
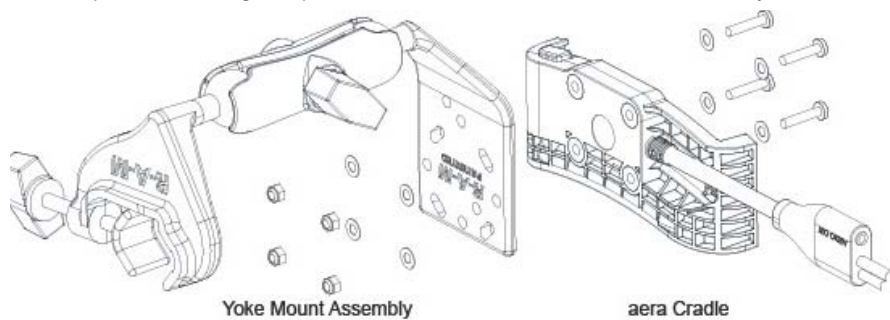

Attaching the yoke mount to the yoke shaft or control arm (see following figure):

- 1) Open the clamp by turning the Clamp Adjustment Knob until it can be easily placed over the yoke shaft or control arm. Install the yoke mount as far from the panel as is practical.
- 2) When in place, tighten the Clamp Adjustment Knob to secure the yoke mount to the yoke shaft or control arm.
- 3) Loosen the Cradle Adjustment Knob, then orient the cradle as desired.
- 4) Tighten the Cradle Adjustment Knob to hold the cradle in place.

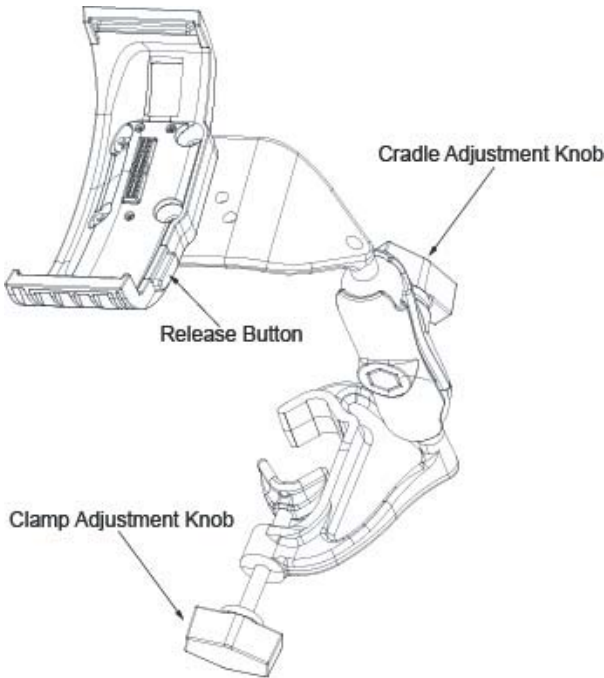

Connecting the cable:

Make all applicable cable connections per the following figure.

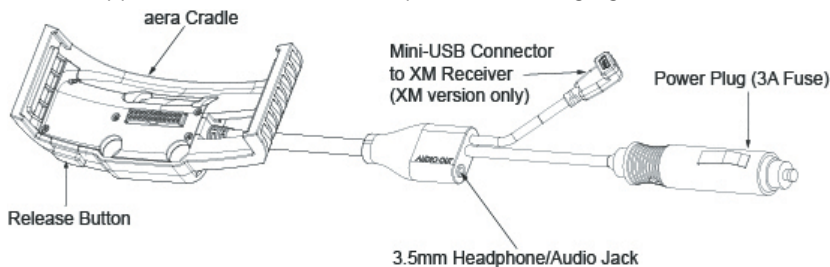

Attaching the aera (portrait orientation) to the yoke mount:

- 1) Fit the left side of the aera into the cradle.
- 2) Press the right side of the aera into the cradle until it snaps into place.

Attaching the aera (landscape orientation) to the yoke mount:

- 1) Fit the bottom of the aera into the cradle.
- 2) Tilt the aera back until it snaps into place.

Removing the aera from the yoke mount:

- 1) Press the Release Button on the side of the cradle to release the aera.
- 2) Remove the aera from the cradle.

Removing the yoke mount from the yoke shaft (or control arm):

- 1) Disconnect the power plug, audio jack, and mini-USB connector (if applicable).
- 2) Loosen the clamp by turning the Clamp Adjustment Knob until the yoke mount assembly can be easily removed from the yoke shaft or control arm.

CONNECTING TO A COMPUTER

The aera 795/796 can be connected to a computer using the included USB-PC Interface Cable to connect to a USB data port.

Connecting the aera 795/796 to a computer:

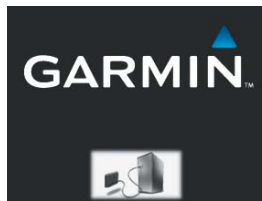

- 1) (Optional Step) Insert a memory card into the memory card slot. Press it in until it clicks.
- 2) Turn the aera 795/796 on.
- 3) Connect the small end of the USB cable to the USB connector on the unit.
- 4) Connect the larger end of the USB cable to a USB port on the computer. The Mass Storage Icon appears on the screen. The aera 795/796 and memory card appear as removable drives in My Computer in Windows and as mounted volumes on Mac computers.



Mass Storage Icon

Mass Storage Mode

Safely disconnecting the USB cable:

- 1) **Windows:** Click  in the toolbar (system tray). **Mac:** Drag the volume icon to the trash can .
- 2) Disconnect the USB cable from the computer.

CONNECTING TO A GARMIN VHF COMM RADIO

The aera 795/796 can also output frequency data to a Garmin aviation radio. Currently the two models supported are the SL30 nav/comm and the SL40 comm.



NOTE: For additional information refer to the SL30 nav/comm or the SL40 comm installation manual.



CAUTION: This interface does not have an FAA installation airworthiness approval. If any abnormalities with SL 30/40 tuning or operation are encountered, disconnect the aera 795/796 from the SL 30/40 tuning interface.

Output frequency data to an SL40/SL30 nav/comm radio:

- 1) Connect the aera 795/796 to an SL30/SL40 using the Aviation Bare Wire Connector (optional accessory).

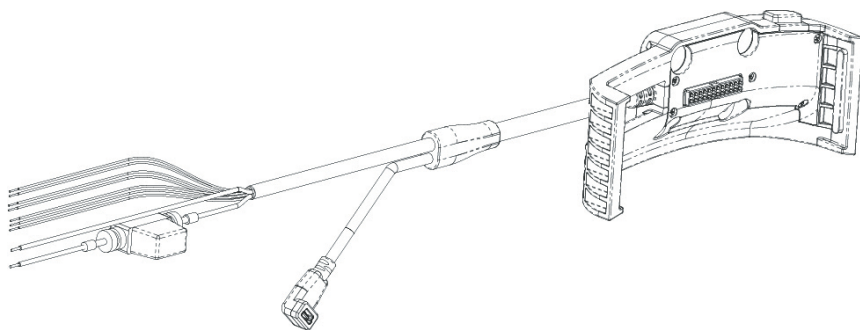

aera 795/796 Aviation Bare Wire Connector

Connection	Wire Color
Power	Red
Power Ground/Data Ground	Black
TX1 (Data Out)	Blue
RX1 (Data In)	Yellow
TX2 (Data Out)	Orange
RX2 (Data In)	Purple
Audio Right	White
Audio Common	Green
Audio Left	Brown

aera 795/796 Aviation Bare Wire Connections

- 2) From the **Main Menu**, touch **Tools > Setup > Interface**.
- 3) Touch the 'Serial Data Format' datafield button. A vertical list is displayed.
- 4) Touch '**Aviation In/NMEA & VHF Out**' or '**TIS In/NMEA & VHF Out**' from the list. These comm modes send both NMEA data and VHF frequency information.

The following features are now available on the radio:

- Remote frequency lists for departure, enroute, and arrival airports.
- Nearest VOR frequencies (SL30 only).

The aera 795/796 can also directly tune a standby frequency.

Selecting a standby comm frequency:

- 1) From the **Main Menu**, touch **WPT Info > Freq Tab**
- 2) Touch the desired frequency from the list. The frequency is now tuned in standby.

Or:

- a) If the frequency has additional information (denoted with an *). Touch the desired frequency from the list.
- b) Touch the '**Tune**' Button.

CONNECTING THE GXM 40 ANTENNA (aera 796)

Connect the GXM 40 antenna to the aera 796 to access SiriusXM Satellite Weather and SiriusXM Radio. For more information about the GXM 40 antenna, see the GXM 40 Owner's Manual.



NOTE: You must subscribe to SiriusXM Radio and/or SiriusXM Satellite Weather to use the SiriusXM Radio and/or SiriusXM Weather features on your aera 796.

Connecting the GXM 40 antenna:

- 1) Position the antenna where it has a clear view of the sky. This can be done behind the windshield.
- 2) Plug the GXM 40 cable into the USB Connector on the appropriate Aviation Mount.

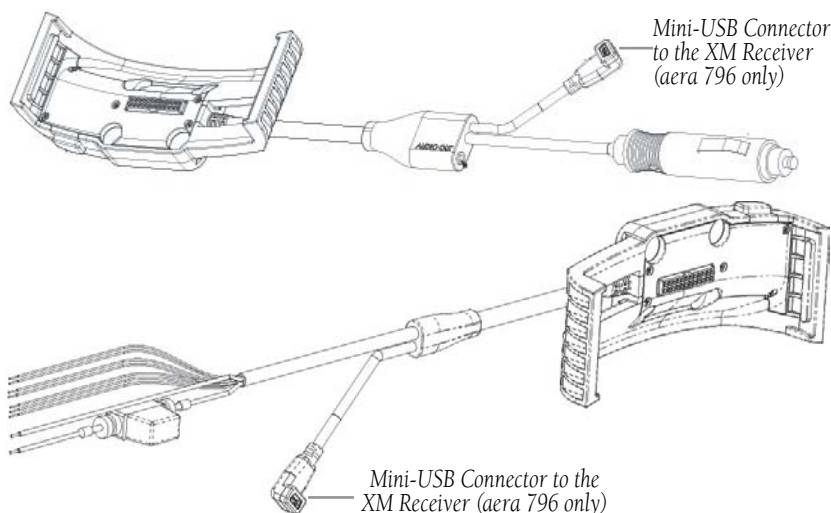

USB Connector to GXM 40 Antenna (XM Aviation Mounts)

CONNECTING TO A GTX 330 MODE S TRANSPONDER

To receive Mode S TIS traffic data from a GTX 330 transponder on your aera 795/796, connect an available RS-232 OUT wire on the transponder to the Data In wire on the aera 795/796. (You do not need to connect the transponder to the aera's Data Out wire.) Then, set the corresponding RS-232 output configuration on the transponder to REMOTE + TIS and set the aera's Serial Data Format to TIS In or TIS In/NMEA & VHF Out. For more information, see the GTX 330 Transponder Installation Manual.

Configuring TIS input:

- 1) Connect the aera 795/796 to the GTX 330 using the Aviation Bare Wire Connector (optional accessory).
- 2) From the **Main Menu**, touch **Tools > Setup > Interface**.
- 3) Touch the 'Serial Data Format' datafield button. A vertical list is displayed.
- 4) Touch '**TIS In**' or '**TIS In/NMEA & VHF Out**'.

The TIS Status field indicates one of the following messages:

- Waiting For Data—searching for a valid TIS data stream.
- Data Available—receiving TIS data from the transponder.
- Data Unavailable—connection to transponder established, but TIS service is unavailable.
- Lost Connection—an error occurred or the connection to the transponder was lost.

INTERFACING

The following formats are supported for connection of external devices: NMEA 0180, 0182, 0183 (versions 1.5, 2.0, 2.3, 3.01), ASCII Text Output, and Garmin proprietary formats for connecting to a Mode S transponder for TIS data, and to a Garmin aviation NAV/COM radio.

The following are the Approved Sentences for NMEA 0183, version 3.01 output: GPRMC, GPGGA, GPGSA, GPGSV, GPGLL, GPBOD, GPRTE, and GPWPL. The following are the Proprietary Sentences for NMEA 0183, version 3.01 output: PGRME, PGRMZ, PGRMM, and PGRMH.

Garmin's proprietary communication protocol is available from the Web site (www.garmin.com).

GENERAL INTERFACE SETUP

The Interface Setup controls the input/output format used when connecting the unit to external devices.

Selecting an interface:

- 1) From the **Main Menu**, touch **Tools** > **Setup** > **Interface**.
- 2) Touch 'Serial Data Format' datafield button. A vertical list is displayed.
- 3) Touch the desired data format from the list ('**Garmin Data Transfer**', '**NMEA Out**', '**Aviation In**', '**Aviation In/NMEA & VHF Out**', '**TIS In**', '**TIS In/NMEA & VHF Out**', or '**None**').
- 4) If a description is needed, touch **Menu** > **Description** or touch the '?'.

Restoring interface defaults:

From the **Main Menu**, touch **Tools** > **Setup** > **Interface** > **Menu** > **Restore Default**.

SERIAL DATA FORMATS

- Garmin Data Transfer—the proprietary format used to exchange data with a PC or another Garmin aera.
- NMEA Out—transmits NMEA position, velocity, and navigation data.
- Aviation In—the proprietary format used for connection to a Garmin panel-mounted GPS receiver. This eliminates the need to enter the destination on both units.
- Aviation In/NMEA & VHF Out—receives aviation data and transmits out both NMEA data, at 9600 baud, and VHF frequency tuning information to a Garmin Nav/Comm radio.
- TIS In—receives TIS data from a Garmin Mode S transponder or other compatible device.
- TIS In/NMEA & VHF Out—receives TIS data and transmits out both NMEA data, at 9600 baud, and VHF frequency tuning information to a Garmin Nav/Comm radio.
- None—provides no interfacing capabilities.

ADVANCED NMEA OUTPUT SETUP

If interfacing the aera 795/796 with another piece of equipment (such as an autopilot), the unit needs to be set to output NMEA data. If the NMEA output mode is set to 'Fast', the unit will output a minimum number of NMEA sentences at 1-second intervals. If the NMEA output is set to 'Normal', the unit will output a greater number NMEA sentences at 2-second intervals.

Setting NMEA output mode:

- 1) From the **Main Menu**, touch **Tools > Setup > Interface**.
- 2) Touch the 'Serial Data Format' datafield. A vertical list is displayed.
- 3) Touch '**NMEA Out**'.
- 4) Touch the 'NMEA Output Mode' **Normal/Fast** toggle button.

NMEA Sentence Output:

- Normal Mode: GPRMB, GPRMC, GPGGA, GPGSA, GPGSV, GPGLL, GPBWC, GPVTG, GPXTE, GPBOD, GPRTE, GPWPL, GPAPB, PGRME, PGRMZ, PGRMM, and PGRMH.
- Fast Mode: GPRMB, GPRMC, PGRMZ, and PGRMH.

USING AN EXTERNAL GPS ANTENNA (OPTIONAL)

The optional GA27C or GA25 external antenna can be used. Connect the antenna to the connector located on the left side of the unit.

Overview

GPS Navigation

Flight Planning

Hazard Avoidance

Additional Features

Appendices

Index

Blank Page

APPENDIX E: BATTERY AND CARE INFORMATION

BATTERY INFORMATION

The aera 795/796 contains a user-replaceable, lithium-ion battery. To maximize the lifetime of the battery, do not leave the aera 795/796 in direct sunlight, and avoid prolonged exposure to excessive heat.

The  battery icon in the top right of the screen indicates the status of the aera 795/796 battery. To increase the accuracy of the battery gauge, fully discharge the battery and fully charge it. Do not unplug the aera 795/796 until it is fully charged.

MAXIMIZING THE BATTERY LIFE

- Turn down the backlight (refer to the 'System Settings').
- Unplug the SiriusXM antenna (if applicable).
- Do not leave the unit in direct sunlight. When storing the device for an extended time, store within the following temperature range: -0° to 40°C).
- Do not operate the unit outside of the following temperature range: -4° to 131°F (-20° to 55°C).
- Avoid prolonged exposure to excessive heat.

REPLACING THE BATTERY IN THE AERA 795/796

To replace the battery, purchase a Garmin lithium-ion replacement battery at <http://buy.garmin.com>. Contact your local waste disposal department for information about properly disposing of the battery.

CHANGING THE CIGARETTE LIGHTER ADAPTER FUSE

If the unit does not charge, the fuse may need to be replaced.

- 1) Unscrew the round end piece, and remove it.
- 2) Remove the fuse (glass and silver cylinder), and replace with a 3A fast-blow fuse.
- 3) Ensure that the silver tip is placed in the end piece. Screw on the end piece.

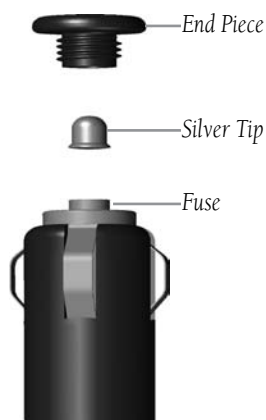

CLEANING THE CASING

The aera 795/796 is constructed of high-quality materials and does not require user maintenance other than cleaning. Clean the outer casing (not the touchscreen) using a cloth dampened with a mild detergent solution, and then wipe dry. Avoid chemical cleaners and solvents that can damage plastic components.

CLEANING THE TOUCHSCREEN

Clean the touchscreen with the included cloth or a soft, clean, lint-free cloth. Use water, isopropyl alcohol, or eyeglass cleaner, if needed. Apply the liquid to the cloth, and then gently wipe the touchscreen.

PROTECTING THE UNIT

- Do not store the aera 795/796 where prolonged exposure to extreme temperature can occur.
- Never use a hard or sharp object to operate the touchscreen.

APPENDIX F: GENERAL TIS INFORMATION



NOTE: Aircraft without an operational transponder are invisible to TIS.



NOTE: TIS is not intended to be used as a collision avoidance system and does not relieve the pilot of the responsibility to “see and avoid” other aircraft. TIS should not be used for avoidance maneuvers during instrument meteorological conditions (IMC) or when there is no visual contact with the intruder aircraft.

The Traffic Information Service (TIS) provides traffic advisory information to non-TAS/TCAS-equipped aircraft. TIS is a ground-based service providing the relative locations of all ATCRBS (Air Traffic Control Radar Beacon System) Mode-A and Mode-C transponder equipped aircraft within a specified service volume. The TIS ground sensor uses real-time track reports to generate traffic notification. The aera 795/796 displays TIS traffic information on the Navigation Map. Surveillance data includes all transponder-equipped aircraft within the coverage volume. The aera 795/796 displays up to eight traffic targets within a 7.5-nm radius, from 3,000 feet below, to 3,500 feet above the requesting aircraft.

TIS VS. TAS/TCAS

The main difference between the Traffic Information System (TIS) and Traffic Advisory (TAS) or Traffic Collision Avoidance Systems (TCAS) is the source of surveillance data. TAS/TCAS uses an airborne interrogator with a half-second update rate, while TIS utilizes the terminal Mode-S ground interrogator and accompanying data link to provide a five-second update rate. TIS and TAS/TCAS have similar ranges.

TIS LIMITATIONS

TIS relies on surveillance of the Mode-S radar system, which is a “secondary surveillance” radar system similar to that used by ATCRBS. Many limitations are inherent in secondary radar surveillance. Information provided by TIS is neither better nor more accurate than the information used by ATC. TIS is intended only to assist in visual acquisition of other aircraft in visual meteorological conditions (VMC). While TIS is a useful aid for visual traffic avoidance, system limitations must be considered to ensure proper use. No recommended avoidance maneuvers are given, nor authorized, as a direct result of a TIS intruder display or TIS advisory.

- TIS operation may be intermittent during turns or other maneuvering.
- TIS is dependent on two-way, line-of-sight communications between the aircraft and the Mode-S radar antenna. Whenever the structure of the aircraft comes between the transponder antenna and the ground-based radar antenna, the signal may be temporarily interrupted.



NOTE: Refer to the *TIS Limitations* section of the *Aeronautical Information Manual (AIM)* for a more comprehensive explanation of limitations and anomalies associated with TIS.



NOTE: TIS is unavailable at low altitudes in many areas of the United States. This is often the case in mountainous regions.



NOTE: Garmin is not responsible for Mode S geographical coverage. Operation of the ground stations is the responsibility of the FAA. Refer to the AIM for a Terminal Mode S radar site map.

TIS information is collected during a single radar sweep. Collected information is then sent through the Mode S uplink on the next radar sweep. Because of this, the surveillance information is approximately five seconds old. TIS ground station tracking software uses prediction algorithms to compensate for this delay. These algorithms use track history data to calculate expected intruder positions consistent with the time of display. Occasionally, aircraft maneuvering may cause variations in this calculation and create slight errors on the Navigation Map which affect relative bearing information and the target track vector and may delay display of the intruder information. However, intruder distance and altitude typically remain relatively accurate and may be used to assist in spotting traffic. The following errors are common examples:

- When the client or intruder aircraft maneuvers excessively or abruptly, the tracking algorithm may report incorrect horizontal position until the maneuvering aircraft stabilizes.
- When a rapidly closing intruder is on a course that intercepts the client aircraft course at a shallow angle (either overtaking or head-on) and either aircraft abruptly changes course within 0.25 nm, TIS may display the intruder aircraft on the incorrect side of the client aircraft.

These are rare occurrences and are typically resolved within a few radar sweeps once the client/intruder aircraft course stabilizes.

Pilots using TIS can provide valuable assistance in the correction of malfunctions by reporting observations of undesirable performance. Reports should identify the time of observation, location, type and identity of the aircraft, and describe the condition observed. Reports should also include the type of transponder and transponder software version. Since TIS performance is monitored by maintenance personnel, not ATC, malfunctions should be reported in the following ways:

- By telephone to the nearest Flight Service Station (FSS) facility
- By FAA Form 8000-7, Safety Improvement Report (postage-paid card can be obtained at FAA FSSs, General Aviation District Offices, Flight Standards District Offices, and General Aviation Fixed Base Operators)

Overview

GPS Navigation

Flight Planning

Hazard Avoidance

Additional Features

Appendices

Index

Blank Page

APPENDIX G: UTILITIES

DOCUMENT VIEWER

Refer to Appendix C: Managing Files and Databases, for information on how to store documents on the aera 795/796.

Accessing a PDF Document using the aera 795/796 Document Viewer:

- 1) From the **Main Menu**, touch **Doc Viewer**.
- 2) Touch the Open Button.
- 3) Touch the desired document from the list.

SCRATCH PAD

The Scratch Pad feature allows the pilot to quickly draw or write down information using only the touchscreen.

Accessing the Scratch Pad:

- 1) From the **Main Menu**, touch **Tools > Scratchpad**
- 2) Touch the screen to begin drawing.

Viewing a previously created Scratch Pad:

- 1) From the **Main Menu**, touch **Tools > Scratchpad > Menu > Open...**
- 2) Touch the desired scratchpad file name from the list.

Clearing the Scratch Pad screen:

With the desired Scratchpad displayed, touch **Menu > Clear Screen**.

Saving a Scratch Pad:

With the desired Scratchpad displayed, touch **Menu > Save**.

Deleting a Scratch Pad:

With the desired Scratchpad displayed, touch **Menu > Delete**.

Changing the Scratch Pad pen color:

- 1) With the desired Scratchpad displayed, touch **Menu > Setup**.
- 2) Touch the 'Pen Color' datafield and select the desired color from the horizontal list.

Changing the Scratch Pad pen width:

- 1) With the desired Scratchpad displayed, touch **Menu** > **Setup**.
- 2) In the 'Pen Width' datafield, touch the  buttons select the desired pen width.

FLIGHT LOG

The Flight Log shows a list of any recorded flights, including date, route of flight, and flight time. The aera 795/796 saves up to 50 recorded flights. Entries on this list are automatically created for each flight.

Recording begins when your speed exceeds 30 knots and you gain 250 feet of altitude. If you land and groundspeed drops below 30 knots, the flight entry is saved and a new entry is recorded when you depart the airport. A touch-and-go or brief stop of less than 10 minutes appends to the current flight record, rather than starting a new entry.

VIEWING THE FLIGHT LOG

Select any listed entry in the log to view additional information, including a map displaying the actual path flown.

Viewing details for a flight:

- 1) From the **Main Menu**, touch **Tools** > **Flight Log**.
- 2) Touch the desired flight log.

Show/Hide hours and minutes for a flight:

- 1) From the **Main Menu**, touch **Tools** > **Flight Log**.
- 2) Touch the desired flight log (if applicable).
- 3) Touch **Menu**.
- 4) Touch '**Show/Hide Hours and Minutes**'.

DELETING FLIGHT LOG RECORDS

You can delete the highlighted flight record or delete all flight records from the Flight Log.

Deleting flight records:

- 1) From the **Main Menu**, touch **Tools > Flight Log**.
- 2) Touch the desired flight log to delete(if applicable).
- 3) Touch **Menu**.
- 4) Touch '**Delete Flight**' or '**Delete All**'.
- 5) Touch **Yes**.

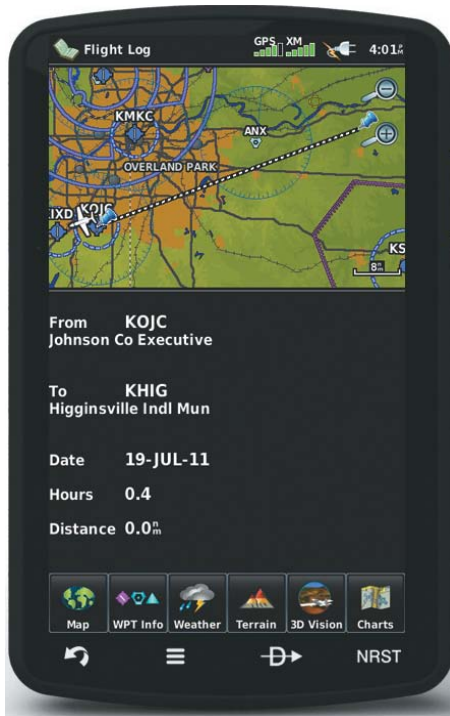

Flight Log

TRACK LOG

The aera 795/796 draws an electronic breadcrumb trail or “track log” on the Navigation Map. The track log contains points along its path, including time, and location for each point.

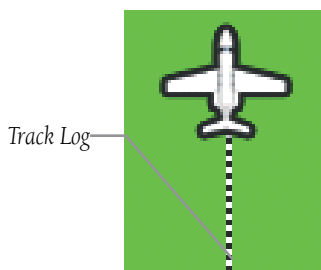

Track Log (Map)

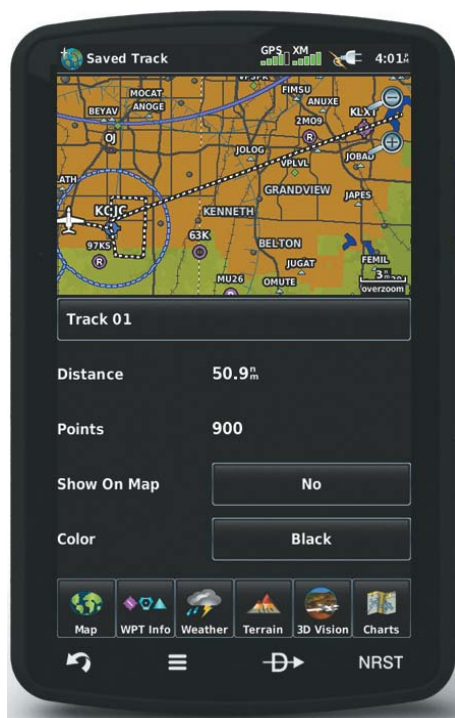

Track Log

The track log starts recording as soon as the aera 795/796 gets a location fix. For the best results, clear the track log before each flight.

The percentage of memory used by the current track log appears at the top of the Track Log Window. After the track log is cleared, it shows zero percent. When the screen reaches 100%, the most recent track points start to overwrite the least recent track points (if 'Wrap' is selected in the Record Mode Field). To avoid losing track points, save the track log when it approaches the 99% mark.

The Save feature allows storage of up to 15 track logs.

Showing/hiding the track log on the Navigation Map:

- 1) From the **Main Menu**, touch **Map > Menu > Set Up Map**.
- 2) Touch the  buttons to display the '**Line**' Category.
- 3) Touch **Track Log**.
- 4) Touch the **Show/Hide** Button.

Changing the track log record mode:

- 1) From the **Main Menu**, touch **Map > Menu > Set Up Map**.
- 2) Touch the  buttons to display the '**Line**' Category.
- 3) Touch the 'Track Record Mode' datafield button, and touch the desired mode from the horizontal list ('**Off**', '**Fill**', or '**Wrap**').

Changing the track log interval:

- 1) From the **Main Menu**, touch **Map > Menu > Set Up Map**.
- 2) Touch the  buttons to display the '**Line**' Category.
- 3) Touch the 'Track Interval' datafield button, and touch the desired interval from the horizontal list ('**Auto**', '**Distance**', or '**Time**').

Changing the track log color:

- 1) From the **Main Menu**, touch **Map > Menu > Set Up Map**.
- 2) Touch the  buttons to display the '**Line**' Category.
- 3) Touch the 'Track Color' datafield button, and touch the desired color from the horizontal list.

Track Log settings are also available from the Track Log Option Menu

- Track Log—Select '**Show**' or '**Hide**' to display/remove the track log on the map.
- Track Record Mode—'**Off**' disables track log recording. '**Fill**' records a track log until the track log is full (100%). '**Wrap**' records over the oldest tracks when the track log reaches 100%.
- Track Interval—'**Distance**' records track points after a specified distance has been traveled. '**Time**' creates track points after a specified time has elapsed. '**Automatic**' saves points that occur after changes in navigation.
- Track Color—Select a color for the track when it appears on the map.

Clearing the track log:

- 1) From the **Main Menu**, touch **Tools** > **Track Log**.
- 2) Touch the desired track log (if applicable).
- 3) Touch **Menu**.
- 4) Touch '**Delete Saved Track**' or '**Delete All Saved Tracks**'.
- 5) Touch **Yes**.

Saving a track log:

- 1) From the **Main Menu**, touch **Tools** > **Track Log** > **Menu** > **Save Active Track**.
- 2) Touch the  buttons to select '**Entire Active Track**', '**Past 24 Hours**', '**Past 7 Days**', or '**Specific Dates**'.
- 3) Enter the Specific Dates (if applicable) and touch **OK**.

Editing a track log:

- 1) From the **Main Menu**, touch **Tools** > **Track Log**.
- 2) Touch the desired track log.
- 3) Touch desired field to edit (**Track Name**, **Show On Map**, or **Color**).

HEADING LINE

The aera 795/796 draws an electronic “heading line” on the Navigation Map. The heading line can be set to time or distance.



Heading Line

Changing the heading line settings on the Navigation Map:

- 1)** From the **Main Menu**, touch **Map > Menu > Set Up Map**.
- 2)** Touch the **◀ ▶** buttons to display the **'Line'** Category.
- 3)** Touch the **'Heading Line'** datafield button, and touch the desired line setting from the horizontal list (**'Off'**, **'Time'**, or **'Distance'**).

E6B CALCULATOR

The E6B Calculator calculates Density Altitude, True Airspeed, Tail Wind, Wind From, and Wind Speed, based on information you enter.

Accessing the E6B calculator:

From the **Main Menu**, touch **Tools** > **E6B Calc.**

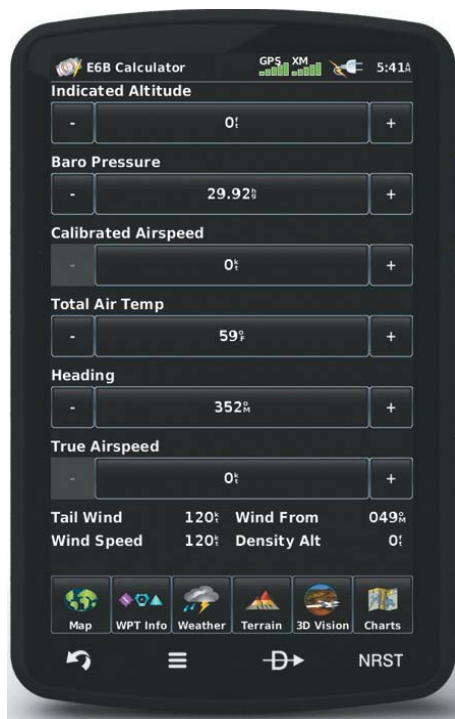

E6B Calculator

- **Indicated Altitude**—required entry for density altitude/true airspeed calculation. Enter the aircraft’s altimeter reading.
- **Baro Pressure**—when the unit is receiving XM weather information, the field automatically updates to the barometric pressure of the nearest METAR. If XM weather information is not available you need to enter the current barometric pressure.
- **Calibrated Airspeed**— required entry for density altitude/true airspeed calculation. Enter the aircraft’s airspeed indicator value.
- **Total Air Temp**— required entry for density altitude/true airspeed calculation. Total Air Temperature (TAT) is the temperature of the air including the heating effect caused by speed. The temperature reading on a standard outside air temperature gauge found on most piston aircraft is TAT.
- **Heading**— required entry for winds aloft calculation. Use heading from the aircraft’s heading indicator or directional gyro.
- **True Airspeed**— (calculated or user-entered figure) determined from entry of calibrated airspeed, barometric pressure, and total air temperature. This can also be entered directly for winds aloft calculations.
- **Tail Wind**— (calculated figure) determined from entry of heading and true airspeed.
- **Wind From**—(calculated figure) determined from entry of heading and true airspeed.
- **Wind Speed**—(calculated figure) determined from entry of heading and true airspeed.
- **Density Altitude**— (calculated figure) determined from entry of indicated altitude, barometric pressure and total air temperature.

Calculating true airspeed and density altitude:

- 1) From the **Main Menu**, touch **Tools** > **E6B Calc**, enter the altitude shown on the altimeter into the 'Indicated Altitude' datafield.
- 2) Repeat for 'Calibrated Airspeed', 'Baro Pressure', and 'Total Air Temperature' datafields. (For Calibrated Airspeed, use the speed shown on the airspeed indicator. Use the current altimeter setting for Baro Pressure. Total Air Temperature is the temperature of the outside air including the heating effect caused by speed. For most aircraft, this is the temperature reading on a standard outside air temperature gauge.) The calculated figures for True Airspeed and Density Altitude are shown in the designated fields.

Calculating winds aloft:

- 1) From the **Main Menu**, touch **Tools** > **E6B Calc**, calculate or enter the true airspeed into the 'True Airspeed' datafield.
- 2) Enter the aircraft heading shown on the directional gyro or compass into the 'Heading' datafield. Tail Wind, Wind From, and Wind Speed are calculated.



NOTE: If True North is selected as the heading reference, a heading referenced to True North must be used to calculate winds accurately.

Restoring E6B calculator defaults:

From the **Main Menu**, touch **Tools** > **E6B Calc** > **Menu** > **Restore Default**.

AIRCRAFT PROFILE

The Aircraft Profile allows the pilot to select cruising speed, maximum speed, fuel flow, and map symbol. The unit can save up to 10 aircraft profiles.

The maximum speed is used to define the range for airspeed on the Panel and is automatically updated if you exceed this figure.

Accessing the aircraft profile:

From the **Main Menu**, touch **Tools** > **Profile**

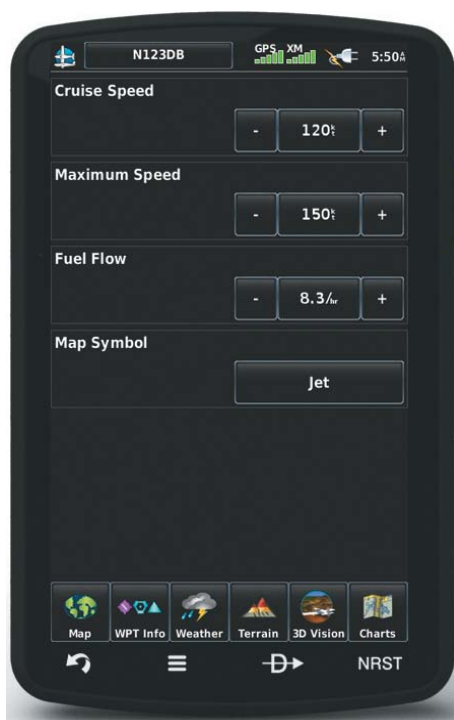

Aircraft Profile

Entering an aircraft profile:

- 1) From the **Main Menu**, touch **Tools > Profile > Menu > New**
- 2) Enter the Aircraft Name using the keypad, and touch **OK**.
- 3) Enter the **Cruise Speed**, **Maximum Speed**, or **Fuel Flow** using the +/- buttons or the keypad.
- 4) Touch the 'Map Symbol' datafield button.
- 5) Touch the **◀▶** buttons to cycle through the available symbols and touch **OK**.

Selecting a saved aircraft profile:

- 1) From the **Main Menu**, touch **Tools > Profile**
- 2) Touch the Aircraft Name Button to access a vertical list of saved profiles (if only two profiles are available touch the Aircraft Name Button to toggle between the two).
- 3) Touch the desired profile from the list.

Renaming a saved aircraft profile:

- 1) From the **Main Menu**, touch **Tools** > **Profile**
- 2) Touch the Aircraft Name Button to access a vertical list of saved profiles.
- 3) Touch the desired profile from the list.
- 4) Touch **Menu** > **Rename**
- 5) Enter the new Aircraft Name using the keypad, and touch **OK**.

Deleting a saved aircraft profile:

- 1) From the **Main Menu**, touch **Tools** > **Profile**
- 2) Touch the Aircraft Name Button to access a vertical list of saved profiles.
- 3) Touch the desired profile from the list.
- 4) Touch **Menu** > **Delete**
- 5) Touch **Yes**.

WEIGHT & BALANCE

Weight & Balance may be used during pre-flight preparations to verify the weight and balance conditions of the aircraft. By entering the weight and arm values, the aera 795/796 can calculate the total weight, moment, and center of gravity (CG).

Before entering the various figures, the empty weight of the airplane and the arm (or "station") for each weight should be determined. These figures should be determined using the pilot's operating handbook for the airplane, which also notes the weight limitations and fore/aft CG limits. Compare those figures to the values calculated by the aera 795/796.

To perform weight and balance calculations:

- 1) From the **Main Menu**, touch **Tools** > **Weight/Bal**
- 2) Touch the datafields to enter the desired weights and arms (or "stations"). The calculated moment, weight, and CG figures appear at the bottom of the screen. Keep in mind that the "Aircraft" (empty weight/arm) figures must be entered as a reference to calculate a valid moment, weight, and CG.
- 3) To empty the aircraft, touch **Menu** > **Empty Aircraft**.



NOTE: This information is only for flight planning purposes. Consult the aircraft's pilot operating handbook for the official weight and balance data.

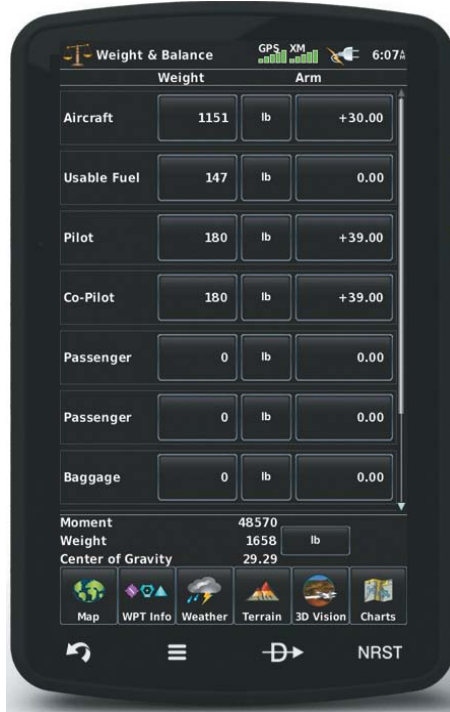

Weight & Balance

PROXIMITY WAYPOINTS

The Proximity Waypoints allows the pilot to define an alarm circle around a waypoint location.

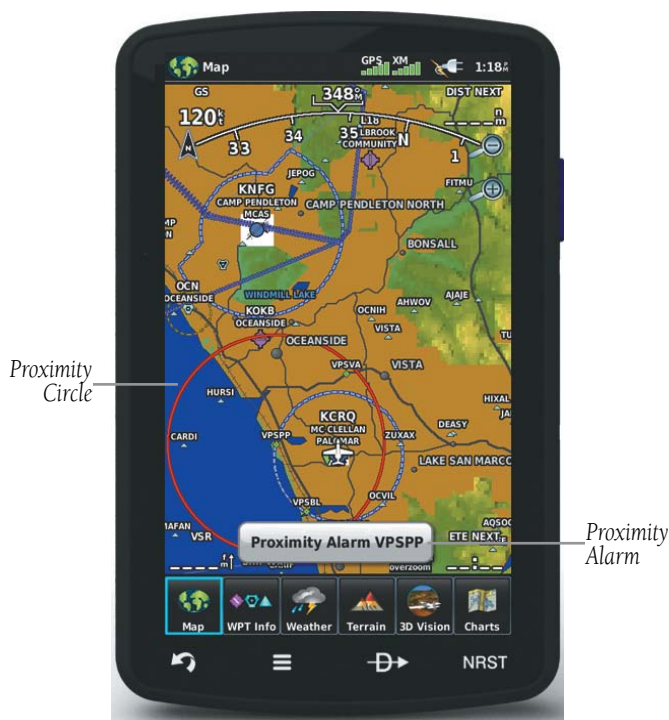

Proximity Waypoints





Defining proximity waypoints:

- 1) From the **Main Menu**, touch **Tools** > **User WPT** > **Proximity Tab** > **Menu** > **New Proximity Waypoint**.
- 2) Touch **'Use Identifier'** or **'Use Map'**.
- 3) Enter the desired identifier or pan the map.
- 4) Touch the newly created Proximity Waypoint, and touch **'Edit Radius'**.
- 5) Enter the desired Radius and touch **OK**.

Setting up and customizing proximity waypoints for the navigation map:

From the **Main Menu**, touch **Tools > User WPT > Proximity Tab > Menu > Enable/Disable Proximity Alarms**.

Or:

- 1) From the **Main Menu**, touch **Map > Menu > Set Up Map**.
- 2) Touch the   buttons to display the **'Point'** Category.
- 3) Touch the 'Proximity Circle'   buttons to select the desired settings (**'Off'**, **'Auto'**, or Range Settings).

Deleting proximity waypoints:

- 1) From the **Main Menu**, touch **Tools > User WPT > Proximity Tab**.
 - a) Touch the desired proximity waypoint.
 - b) Touch the **'Delete Proximity Waypoint'** menu option.
- Or:**
- a) Touch the **Menu** Icon
 - b) Touch the **'Delete All'** menu option.
- 2) Touch **Yes**.

Overview

GPS Navigation

Flight Planning

Hazard Avoidance

Additional Features











Appendices

Index







Blank Page

APPENDIX H: DISPLAY SYMBOLS









VFR SYMBOLS

Item	Symbol
Unknown	
Non-towered, Non-serviced	
Towered, Non-serviced	
Non-towered, Serviced	
Towered, Serviced	
Soft Surface, Non-serviced	
Soft Surface, Serviced	
Soft Surface, Private	
Paved, Private	
Seaplane Base	
Heliport	

Americas/Pacific Database Airports

Item	Symbol
Civilian, Non-serviced	
Military, Non-serviced	
Civilian, Serviced	
Military, Serviced	
Civilian, Soft/Unknown Surface, Non-serviced	
Civilian, Soft/Unknown Surface, Serviced	

Atlantic Database Airports



Item	Symbol
Intersection	
Visual Reporting Point	
LOM (compass locator at outer marker)	
NDB (non-directional radio beacon)	
VOR	
VOR/DME	
ILS/DME or DME only	
VORTAC	
TACAN	

Nav aids



Item	Symbol
Interstate Highway	
US Highway	
State Highway	
National Highway	
Small City	
Medium City	
Large City	

Miscellaneous











IFR SYMBOLS

Item	Symbol
VFR, Soft/unknown Surface, Non-serviced	
VFR, Soft/unknown Surface, Serviced	









Atlantic Database Airports

Item	Symbol
Low-Altitude	
High-Altitude	

Airways

Item	Symbol
Unknown	
VFR Airport, Non-serviced	
IFR Airport, Non-serviced	
VFR Airport, Serviced	
IFR Airport, Serviced	
VFR, Soft Surface, Non-serviced	
VFR, Soft Surface, Serviced	
VFR, Soft Surface, Private	
VFR, Paved, Private	
VFR Seaplane Base	
VFR Heliport	

Americas/Pacific Database Airports

Item	Symbol
Intersection	
LOM (compass locator at outer marker)	
NDB (non-directional radio beacon)	
VOR	
VOR/DME	
ILS/DME or DME Only	
VORTAC	
TACAN	

Nav aids



AIRSPACE SYMBOLS

Item	Symbol
Class B, Class E, CTA	
Class A, Class C, TMA	
Class D	
Mode C Veil	
TRSA	
MOA	
Danger, Alert, or Training Area	
Restricted, Prohibited, or Warning Area	
Radar Area	
ATZ, TIZ	
MATZ	
ADIZ	
Misc/Unknown	

VFR Americas/Pacific Database

Item	Symbol
Class B, Class E, CTA	
Class A, Class C, TMA, TRSA	
Class D	
MOA	
Danger, Alert, or Training Area	
Restricted, Prohibited, or Warning Area	
Radar Area	
ATZ, TIZ	
Misc/Unknown	

IFR Americas/Pacific Database

Item	Symbol
Danger or Alert Area	
Restricted, Prohibited, or Warning Area	
Training Area	

VFR Atlantic Database Exceptions

Item	Symbol
Training Area	

IFR Atlantic Database Exceptions

Overview

GPS Navigation

Flight Planning

Hazard Avoidance

Additional Features

Appendices

Index

Blank Page

APPENDIX I: MAP DATUM AND LOCATION FORMATS

MAP DATUMS

A datum is a mathematical model of the Earth that approximates the shape of the Earth and enables calculations to be carried out in a consistent and accurate manner. The datum is physically represented by a framework of ground monuments (such as trig. stations) whose locations have been accurately measured and calculated on this reference surface. Lines of latitude and longitude on a chart are referenced to a specific map datum. Every chart has a map datum reference and the aera 795/796 can be set to match most of those commonly used.

LOCATION FORMATS

Your current location can be viewed on the GPS in the form of coordinates. Since different charts use different location formats, Garmin GPS units allow you to choose the correct coordinate system for the type of chart you are using. The most common format is latitude and longitude, which is used by all Garmin units. You can change the location format to use with other coordinate systems. Several other grids, including a user-definable grid (for the advanced user), are available.

Overview

GPS Navigation

Flight Planning

Hazard Avoidance

Additional Features

Appendices

Index

Blank Page

APPENDIX J: GLOSSARY

ADIZ	Air Defense Identification Zone
AGL	Above Ground Level
AIRMET	Airman’s Meteorological Information
ARTCC	Air Route Traffic Control Center
ASOS	Automated Surface Observing System
ATC	Air Traffic Control
ATIS	Automatic Terminal Information Service
AWOS	Automated Weather Observing System
Bearing	The compass direction from the present position to a destination waypoint.
°C	degrees Celsius
Calibrated Airspeed	Indicated airspeed corrected for installation and instrument errors.
cm	centimeter
COM	communication radio
Course	The line between two points to be followed by the aircraft.
Course to Steer	The recommended direction to steer in order to reduce course error or stay on course. Provides the most efficient heading to get back to the desired course and proceed along the flight plan.
Crosstrack Error	The distance the aircraft is off a desired course in either direction, left or right.
dBZ	decibels ‘Z’ (radar return)
deg	degree
Desired Track	The desired course between the active “from” and “to” waypoints.
DIS	distance

Overview

Distance	The 'great circle' distance from the present position to a destination waypoint.
DME	Distance Measuring Equipment
DTK	Desired Track

GPS Navigation

Enroute Safe Altitude	The recommended minimum altitude within ten miles left or right of the desired course on an active flight plan or direct-to.
ESA	Enroute Safe Altitude

Flight Planning

Estimated Time of Arrival	The estimated time at which the aircraft should reach the destination waypoint, based upon current speed and track.
Estimated Time Enroute	The estimated time it takes to reach the destination waypoint from the present position, based upon current ground speed.

Hazard Avoidance

ETA	Estimated Time of Arrival
ETE	Estimated Time Enroute

Additional Features

°F	degrees Fahrenheit
FAA	Federal Aviation Administration
FAF	Final Approach Fix
FCC	Federal Communication Commission
fpm	feet per minute
FSS	Flight Service Station
ft	foot/feet

Appendices

gal	gallon(s)
Glide Ratio, G/R	The estimated distance an aircraft will move forward for any given amount of lost altitude.

Index

gph	gallons per hour
GPS	Global Positioning System

Grid MORA	Grid Minimum Off-Route Altitude; one degree latitude by one degree longitude in size and clears the highest elevation reference point in the grid by 1000 feet for all areas of the grid
Groundspeed	The velocity that the aircraft is travelling relative to a ground position.
Ground Track	see Track
GS	Ground speed
Heading	The direction an aircraft is pointed, based upon indications from a magnetic compass or a properly set directional gyro.
Hg	mercury
hPa	hectopascal
hr	hour
HSI	Horizontal Situation Indicator
Hz	Hertz
IAF	Initial Approach Fix
IAT	Indicated Air Temperature
ICAO	International Civil Aviation Organization
IFR	Instrument Flight Rules
ILS	Instrument Landing System
IMC	Instrument Meteorological Conditions
in	inch
Indicated	Information provided by properly calibrated and set instrumentation on the aircraft panel.
in HG	inches of mercury
kg	kilogram
kHz	kilohertz
km	kilometer

Overview

kt knot

LAT latitude

lb pound

GPS Navigation

Leg The portion of a flight plan between two waypoints.

LOC localizer

LON longitude

Flight Planning

m meter

MAP Missed Approach Point

METAR Meteorological Aviation Routine

MHz megahertz

Hazard Avoidance

Minimum Safe Altitude Uses Grid MORAs to determine a safe altitude within ten miles of the aircraft present position.

MOA Military Operations Area

MSA Minimum Safe Altitude

MSL Mean Sea Level

Additional Features

NAVAID NAVigation AID

NDB Non-directional Beacon

NEXRAD Next Generation Radar

nm nautical mile(s)

Appendices

OAT Outside Air Temperature

OBS Omni Bearing Selector

Index

psi pounds per square inch

QTY quantity

rpm	revolutions per minute
SBAS	Satellite-Based Augmentation System
SD	Secure Digital
sec	second(s)
SIGMET	Significant Meteorological Information
TA	Traffic Advisory
TACAN	Tactical Air Navigation System
TAF	Terminal Aerodrome Forecast
TAS	True Airspeed
TCAS	Traffic Collision Avoidance System
TFR	Temporary Flight Restriction
TIS	Traffic Information System
Track	Direction of aircraft movement relative to a ground position; also 'Ground Track'
TRSA	Terminal Radar Service Area
UTC	Coordinated Universal Time
VFR	Visual Flight Rules
VHF	Very High Frequency
VNAV	vertical navigation
VOR	VHF Omni-directional Range
VORTAC	very high frequency omnidirectional range station and tactical air navigation
VSI	Vertical Speed Indicator
VSR	Vertical Speed Required
VTF	vector to final

WAAS

Wide Area Augmentation System

WX

weather

APPENDIX K: LICENSE AGREEMENT AND WARRANTY

CONTACT GARMIN

Contact Garmin if you have any questions while using your aera 795/796. In the USA, contact Garmin Product Support by phone: (913) 397-8200 or (866) 739-5687, Monday–Friday, 7 AM–7 PM Central Time; or go to <https://fly.garmin.com/fly-garmin/support>.

In Europe, contact Garmin (Europe) Ltd. at +44 (0) 870.8501241 (outside the UK) or 0808 2380000 (within the UK).

SOFTWARE LICENSE AGREEMENT

BY USING THE aera 795/796, YOU AGREE TO BE BOUND BY THE TERMS AND CONDITIONS OF THE FOLLOWING SOFTWARE LICENSE AGREEMENT. PLEASE READ THIS AGREEMENT CAREFULLY.

Garmin grants you a limited license to use the software embedded in this device (the “Software”) in binary executable form in the normal operation of the product. Title, ownership rights, and intellectual property rights in and to the Software remain with Garmin.

You acknowledge that the Software is the property of Garmin and is protected under the United States of America copyright laws and international copyright treaties. You further acknowledge that the structure, organization, and code of the Software are valuable trade secrets of Garmin and that the Software in source code form remains a valuable trade secret of Garmin. You agree not to decompile, disassemble, modify, reverse assemble, reverse engineer, or reduce to human readable form the Software or any part thereof or create any derivative works based on the Software. You agree not to export or re-export the Software to any country in violation of the export control laws of the United States of America.

LIMITED WARRANTY

This Garmin product is warranted to be free from defects in materials or workmanship for one year from the date of purchase. Within this period, Garmin will, at its sole option, repair or replace any components that fail in normal use. Such repairs or replacement will be made at no charge to the customer for parts or labor, provided that the customer shall be responsible for any transportation cost. This warranty does not cover failures due to abuse, misuse, accident, or unauthorized alteration or repairs. In addition, Garmin reserves the right to refuse warranty claims against products or services that are obtained and/or used in contravention of the laws of any country.

This product is intended to be used only as a travel aid and must not be used for any purpose requiring precise measurement of direction, distance, location, or topography. Garmin makes no warranty as to the accuracy or completeness of map data in this product.

THE WARRANTIES AND REMEDIES CONTAINED HEREIN ARE EXCLUSIVE AND IN LIEU OF ALL OTHER WARRANTIES EXPRESS, IMPLIED, OR STATUTORY, INCLUDING ANY LIABILITY ARISING UNDER ANY WARRANTY OF MERCHANTABILITY OR FITNESS FOR A PARTICULAR PURPOSE, STATUTORY OR OTHERWISE. THIS WARRANTY GIVES YOU SPECIFIC LEGAL RIGHTS, WHICH MAY VARY FROM STATE TO STATE.

IN NO EVENT SHALL GARMIN BE LIABLE FOR ANY INCIDENTAL, SPECIAL, INDIRECT, OR CONSEQUENTIAL DAMAGES, WHETHER RESULTING FROM THE USE, MISUSE, OR INABILITY TO USE THIS PRODUCT OR FROM DEFECTS IN THE PRODUCT. SOME STATES DO NOT ALLOW THE EXCLUSION OF INCIDENTAL OR CONSEQUENTIAL DAMAGES, SO THE ABOVE LIMITATIONS MAY NOT APPLY TO YOU.

Garmin retains the exclusive right to repair or replace the unit or software or offer a full refund of the purchase price at its sole discretion. SUCH REMEDY SHALL BE YOUR SOLE AND EXCLUSIVE REMEDY FOR ANY BREACH OF WARRANTY.

To obtain warranty service, contact your local Garmin authorized dealer or call Garmin Product Support for shipping instructions and an RMA tracking number. Securely pack the unit and a copy of the original sales receipt, which is required as the proof of purchase for warranty repairs. Write the tracking number clearly on the outside of the package. Send the unit, freight charges prepaid, to any Garmin warranty service station.

Online Auction Purchases: Products sold through online auctions are not eligible for rebates or other special offers from Garmin. Online auction confirmations are not accepted for warranty verification. To obtain warranty service, an original or copy of the sales receipt from the original retailer is required. Garmin will not replace missing components from any package purchased through an online auction.

International Purchases: A separate warranty is provided by international distributors for units purchased outside the United States. This warranty is provided by the local in-country distributor and this distributor provides local service for your unit. Distributor warranties are only valid in the area of intended distribution. Units purchased in the United States or Canada must be returned to the Garmin service center in the United Kingdom, the United States, Canada, or Taiwan for service.

AOPA AIRPORT DIRECTORY NOTICE

AOPA MEMBERSHIP PUBLICATIONS, INC. AND ITS RELATED ORGANIZATIONS (HEREINAFTER COLLECTIVELY "AOPA") EXPRESSLY DISCLAIM ALL WARRANTIES, WITH RESPECT TO THE AOPA INFORMATION INCLUDED IN THIS DATA, EXPRESS OR IMPLIED, INCLUDING, BUT NOT LIMITED TO, THE IMPLIED WARRANTIES OF MERCHANTABILITY AND FITNESS FOR A PARTICULAR PURPOSE. THE INFORMATION IS PROVIDED "AS IS" AND AOPA DOES NOT WARRANT OR MAKE ANY REPRESENTATIONS REGARDING ITS ACCURACY, RELIABILITY, OR OTHERWISE. UNDER NO CIRCUMSTANCES INCLUDING NEGLIGENCE, SHALL AOPA BE LIABLE FOR ANY INCIDENTAL, SPECIAL OR CONSEQUENTIAL DAMAGES THAT RESULT FROM THE USE OR INABILITY TO USE THE SOFTWARE OR RELATED DOCUMENTATION, EVEN IF AOPA OR AN AOPA AUTHORIZED REPRESENTATIVE HAS BEEN ADVISED OF THE POSSIBILITY OF SUCH DAMAGES. USER AGREES NOT TO SUE AOPA AND, TO THE MAXIMUM EXTENT ALLOWED BY LAW, TO RELEASE AND HOLD HARMLESS AOPA FROM ANY CAUSES OF ACTION, CLAIMS OR LOSSES RELATED TO ANY ACTUAL OR ALLEGED INACCURACIES IN THE INFORMATION ARISING OUT OF GARMIN'S USE OF THE INFORMATION IN THE DATASETS. SOME JURISDICTIONS DO NOT ALLOW THE LIMITATION OR EXCLUSION OF IMPLIED WARRANTIES OR LIABILITY FOR INCIDENTAL OR CONSEQUENTIAL DAMAGES SO THE ABOVE LIMITATIONS OR EXCLUSIONS MAY NOT APPLY TO YOU.

SIRIUSXM SATELLITE RADIO SERVICE AGREEMENT

SiriusXM Satellite Radio Inc.

Hardware and required monthly subscription sold separately. Subscription fee is consumer only. Other fees and taxes, including a one-time activation fee may apply. All programming fees and weather data subject to change. SiriusXM WX weather data displays and individual product availability vary by hardware equipment. Reception of the SiriusXM signal may vary depending on location. Subscriptions subject to Customer Agreement included with the SiriusXM Welcome Kit and available at xmradio.com. Available only in the 48 contiguous United States. SiriusXM WX is a trademark of SiriusXM Satellite Radio Inc.

Contact SiriusXM Satellite Radio by phone at 800.985.9200 to subscribe to SiriusXM WX Weather and/or SiriusXM Radio.

WEATHER DATA WARRANTY

THE WEATHER DATA SOFTWARE PRODUCT IS PROVIDED "AS IS." ALL OTHER WARRANTIES, EXPRESSED OR IMPLIED, INCLUDING ANY WARRANTY OF MERCHANTABILITY OR FITNESS FOR A PARTICULAR PURPOSE OR OF NON-INFRINGEMENT ARE HEREBY EXCLUDED.

USER SAFETY

If you use SiriusXM Services it is your responsibility to exercise prudent discretion and observe all safety measures required by law and your own common sense. You assume the entire risk related to your use of the Services. SiriusXM and Garmin assume no responsibility for accidents resulting from or associated with use of the Services. Your Radio Service includes traffic and weather information, and you acknowledge that such information is not for "safety for life", but is merely supplemental and advisory in nature, and therefore cannot be relied upon as safety-critical in connection with any aircraft, sea craft or automobile usage. This information is provided "as is" and SiriusXM and Garmin disclaim any and all warranties, express and implied, with respect thereto or the transmission or reception thereof. SiriusXM and Garmin further do not warrant the accuracy, reliability, completeness or timeliness of the traffic and weather information disclosed on the Radio Service. In no event will SiriusXM and Garmin, their data suppliers, service providers, marketing/distribution, software or Internet partners or hardware manufacturers be liable to you or to any third party for any direct, indirect, incidental, consequential, special, exemplary or punitive damages or lost profits resulting from use of or interruptions in the transmission or reception of the Services.

LIMITS ON OUR RESPONSIBILITY

a) DISCLAIMERS.

EXCEPT AS EXPRESSLY PROVIDED HEREIN, WE MAKE NO WARRANTY OR REPRESENTATION, EITHER EXPRESS OR IMPLIED, REGARDING THE RADIO SERVICE. YOUR USE OF THE SERVICE IS AT YOUR SOLE RISK. THE CONTENT AND FUNCTIONALITY OF THE SERVICE IS PROVIDED "AS IS" WITHOUT ANY WARRANTY OF ANY KIND, EXPRESS OR IMPLIED. ALL SUCH WARRANTIES OR REPRESENTATIONS (INCLUDING, WITHOUT LIMITATION, THE IMPLIED WARRANTIES OF MERCHANTABILITY, FITNESS FOR A PARTICULAR PURPOSE, TITLE AND NON-INFRINGEMENT) ARE HEREBY DISCLAIMED.

b) LIMITATIONS OF LIABILITY.

WE ARE NOT RESPONSIBLE FOR ANY SPECIAL, INCIDENTAL, OR CONSEQUENTIAL DAMAGES OR LOSSES RELATING TO THE USE OF THE RADIO SERVICE, WHETHER BASED ON NEGLIGENCE OR OTHERWISE. OUR TOTAL LIABILITY TO YOU AND ANY OTHER PERSONS RECEIVING OUR SERVICES, REGARDLESS OF THE CAUSE, WILL IN NO EVENT EXCEED THE AMOUNTS THAT YOU HAVE PAID TO US FOR THE SERVICE THAT YOU RECEIVED DURING THE SIX (6) MONTH PERIOD IMMEDIATELY PRIOR TO THE SPECIFIC EVENT THAT GAVE RISE TO THE APPLICABLE DAMAGE OR LOSS. THIS ALLOCATION OF RISK IS REFLECTED IN OUR PRICES. YOU MAY HAVE GREATER RIGHTS THAN DESCRIBED ABOVE UNDER YOUR STATE'S LAWS

This product was developed using DAFIF™, a product of the National Geospatial-Intelligence Agency.

This product has not been endorsed or otherwise approved by the National Geospatial-Intelligence Agency, or the United States Department of Defense (10 U.S.C. 425)

a. Under 10 U.S.C. 456, no civil action may be brought against the United States on the basis of the content of a navigational aid prepared or disseminated by either the former Defense Mapping Agency (DMA), National Imagery and Mapping Agency (NIMA), or the National Geospatial-Intelligence Agency (NGA).

b. The DAFIF™ product is provided “as is,” and no warranty, express or implied, including, but not limited to the implied warranties of merchantability and fitness for particular purpose or arising by statute or otherwise in law or from a course of dealing or usage in trade, is made by NGA as to the accuracy and functioning of the product.

c. Neither NGA nor its personnel will be liable for any claims, losses, or damages arising from or connected with the use of this product. The user agrees to hold harmless the United States National Geospatial-Intelligence Agency. The user’s sole and exclusive remedy is to stop using the DAFIF product.

FCC COMPLIANCE

This device complies with part 15 of the FCC Rules. Operation is subject to the following two conditions: (1) this device may not cause harmful interference, and (2) this device must accept any interference received, including interference that may cause undesired operation.

This equipment has been tested and found to comply with the limits for a Class B digital device, pursuant to part 15 of the FCC rules. These limits are designed to provide reasonable protection against harmful interference in a residential installation. This equipment generates, uses, and can radiate radio frequency energy and may cause harmful interference to radio communications if not installed and used in accordance with the instructions. However, there is no guarantee that interference will not occur in a particular installation. If this equipment does cause harmful interference to radio or television reception, which can be determined by turning the equipment off and on, the user is encouraged to try to correct the interference by one of the following measures:

- Reorient or relocate the receiving antenna.
- Increase the separation between the equipment and the receiver.
- Connect the equipment into an outlet that is on a different circuit from the GPS unit.
- Consult the dealer or an experienced radio/TV technician for help.

This product does not contain any user-serviceable parts. Repairs should only be made by an authorized Garmin service center. Unauthorized repairs or modifications could result in permanent damage to the equipment, and void your warranty and your authority to operate this device under Part 15 regulations.

INDUSTRY CANADA COMPLIANCE

Category I radio communication devices comply with Industry Canada Standard RSS-210.

A

- Abnormal Operation 133
- Acquiring Satellites 6
- Additional Features 105
- Aircraft Profile 166
- AIRMETs 87
- Airspace 60
 - Alert Messages 61
 - Smart 62
- Airspace Messages 129
- Airways 44
- Alerts 127
 - Terrain 99
- AOPA Data 106, 109, 117
- Approach
 - Selecting 75
- ARTCC 59
- Aural Alerts 100, 131
- Autolocate 6
- Autozoom 19

B

- Backlight 25, 26
- Baro Pressure 165
- Battery
 - Charging 3
 - Information 151
 - Installation 2
 - Life 151
 - Replacement 151
- BKSP 15
- Bug Indicator 36, 38

C

- cards, data 134
- Category 121

- Channel List 122
- Charge Mode 4
- Charging, the battery 3
- Chart Not Available 112, 115
- Cities 59
- Compass Arc 36
 - Bug Indicator 36
- Computer, connecting to 143
- Copying, Flight Plans 72
- Course, setting 38
- Current Icing Product (CIP) 90

D

- Database
 - Jeppesen 137
- Databases 134
- data card 134
- Data Entry 15
 - Alphanumeric Data 16
 - Predetermined Data Option 17
- Data Field
 - Options 34
- Data Field Options 127
- Data Fields 32, 129
- Declutter 22
- Dedicated Icons 10
- Direct-to 10, 63
 - Cancelling 64
- Display
 - Backlight Intensity 24
 - Backlight Timeout 25, 26
- Display Orientation 8

E

- Echo Tops 83
- external GPS Antenna 149

F

- Favorites 123
- Flight Log 157, 158
- Flight Plan
 - Activation 70, 71
 - Active 67
 - Copying 72
 - Creation 67
 - Data Fields 66
 - Deleting 72
 - Fuel Flow 71
 - Inverting 73
- FliteCharts 114
 - Range 113
- Flight Plan
 - Storage 68
- Forecast 90
- Freezing Levels 89
- FSS 59
- Fuel Flow 71
- Fuse, changing 151

G

- GPS Navigation 31
- GPS Receiver Status 6
- GTX 330 147
- GXM 40 Antenna 146

H

- Hazard Display 133
- Heading Line 163, 164
- HSI/Panel 37

I

- Icing Forecast 90
- Interfacing 147
- Intersections 55
- Inverting, flight plans 73

Index-2

J

- Jeppesen 137

L

- Lightning 84
- Location Formats 179
- Loss of GPS Position 133
- Lost Satellite Reception 6

M

- Map
 - Autozoom 19
 - Declutter 22
 - Detail 23
 - Display Setup 42
 - Orientation 43
 - Overlays 22
 - Panning 20
 - Range 18, 19
 - Symbols 22, 173
- Map Datum 179
- Map Feature
 - Button 20
 - Information 21, 117
- Message Advisories 127
- Messages 127
- METARs 85
- Mounting, in aircraft 139

N

- NDBs 55
- Nearest 11, 48, 50
 - Airport Criteria 51
- Nearest Airport Criteria 28
 - Entering 28
 - Restoring 28
- Nearest Type, Changing 29
- New Location 29

NEXRAD 81
 NMEA 149
 Numeric Data Options 129
 Numeric Flight Data 35

O

Obstacle
 Color Code 97
 Obstacles 96
 Option Menu 15
 Orientation, map 43
 Overlay
 Terrain 22
 Topography 22
 Weather 22
 Overlays
 Displaying/removing 22, 24, 25

P

Panel 37
 Panning 9
 PIREPs 88
 POWER Button 5
 Present Position 28
 Proximity Waypoints 170

R

Red X 133
 Runways 46

S

SafeTaxi 111, 118
 Satellite Information 7
 Satellite Mosaic 82
 Scrolling 9
 SD Card 134
 Searching the Sky 6
 Settings 23

SIGMETs 87
 Simulator Mode 29
 Smart Airspace 62
 Sound
 Adjusting 26
 Muting 26
 Storm Cells 84
 Supercooled Large Droplet (SLD) 90
 Surface Pressure 91
 System Settings
 Display 24

T

TAFs 85
 Temporary Flight Restrictions (TFRS) 88
 Terrain 95
 Alerts 99
 Audio 101
 Aural Alerts 100
 Views 98
 Tools 13
 Touchscreen 8
 Touchscreen, cleaning 152
 Track Log 160
 Traffic Data 103
 Traffic Ground Track 103
 Traffic Information Service (TIS) 101
 Alerts 102
 Configuring 147
 Symbology 101
 Transponder 147
 Turbulence Forecast 89

U

User Waypoints 57
 Creating 57
 Deleting 58
 Utilities 157

V

- Vectors-to-Final 77
- Vertical Navigation (VNAV) 39
 - Profile 42
- VHF Comm Radio 144
- VORs 56

W

- Warranty 187
- Water Temperature 92
- Waypoints 44
 - Proximity 170
 - User 57
- Weather 52
- Weather Products 80
- Weight & Balance 168
- Winds Aloft 83

X

- XM
 - Activating 79
 - Animating 95
 - Legends 95
 - Radio 119
 - Radio ID 79
 - Weather 79
 - Weather Products 80
 - XM Satellite Radio 126

Z

- Zooming 9



Garmin International, Inc.
1200 East 151st Street
Olathe, KS 66062, U.S.A.
Toll free: 800.800.1020 or
866.739.5687
p: 913.397.8200
f: 913.397.8282

Garmin AT, Inc.
2345 Turner Road SE
Salem, OR 97302, U.S.A.
Toll free: 800.525.6726
p: 503.391.3411
f: 503.364.2138

Garmin (Europe) Ltd
Liberty House, Bulls Copse Road
Hounslow Business Park
Southampton, SO40 9RB, U.K.
Toll free (within U.K.) 0808.2380000
p: 44/0870.8501241
f: 44/0870.8501251

Garmin Corporation
No. 68, Jangshu 2nd Road
Shijr, Taipei County, Taiwan
p: 886/2.2642.9199
f: 886/2.2642.9099

www.garmin.com